

Automatización

Contactores - Línea CWM

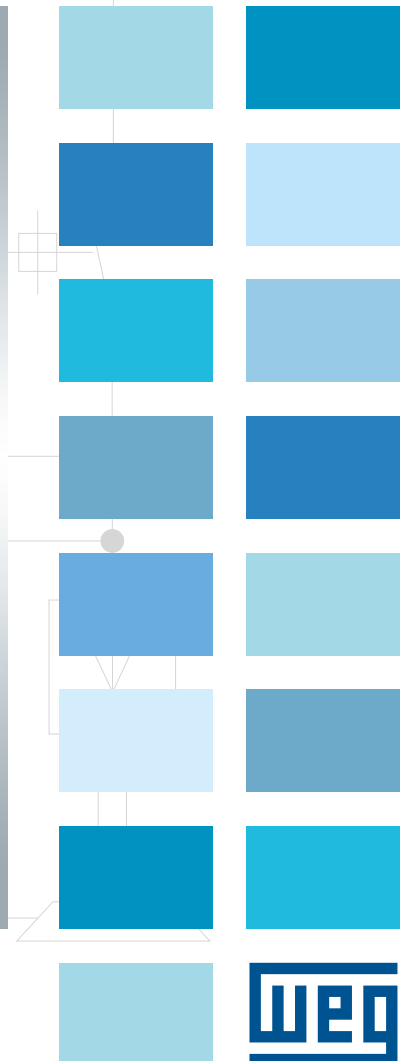

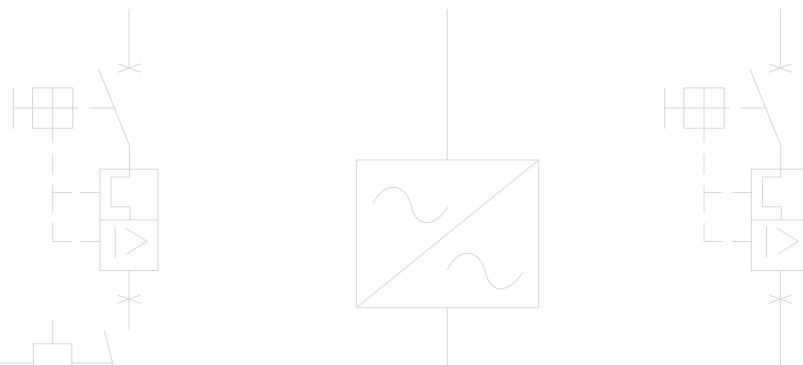

WEG CWM 40
EC 947 VDE 660-6-100V
R_{th} = 25A 100V
Coul. Amp. 100V
I_{th} 100V
AC 3

V	220	400	480	600	690
IN	11	16.5	22	28	33
IP	15	22	28	35	40

UL LISTED
NO COILS
ETIA

WEG CWM40

IP	1	2	3	4
100V	11	16.5	22	28
200V	16.5	22	28	33
300V	22	28	35	40
400V	28	35	40	48
600V	35	40	48	58

WEG CWM40

WEG CWM 105
EC 947 VDE 660-6-100V
R_{th} = 25A 100V
Coul. Amp. 100V
I_{th} 100V
AC 3

V	220	400	480	600	690
IN	11	16.5	22	28	33
IP	15	22	28	35	40

UL LISTED
NO COILS
ETIA

WEG CWM105

IP	1	2	3	4	5	6
100V	11	16.5	22	28	33	38
200V	16.5	22	28	35	40	46
300V	22	28	35	40	48	54
400V	28	35	40	48	58	64
600V	35	40	48	58	68	74

WEG CWM105

WEG CWM 18
EC 947 VDE 660-6-100V
R_{th} = 25A 100V
Coul. Amp. 100V
I_{th} 100V
AC 3

V	220	400	480	600	690
IN	4	7.5	11	14	16
IP	6	11	15	19	22

UL LISTED
NO COILS
ETIA

WEG CWM18

IP	1	2	3	4
100V	4	7.5	11	14
200V	7.5	11	14	17
300V	11	14	17	21
400V	14	17	21	26
600V	17	21	26	32

WEG CWM18

WEG CWM 250

1L1	3L2	5L3
2T1	4T2	6T3

WEG CWM250

Contadores - Linea CWM

Sumario

Introducción	04
Visión General de Los Accesorios	05
Contactores Tripolares de 9 hasta 250 A (AC-3) - Bobina CA	09
Contactores Tripolares de 40 hasta 105 A (AC-3) - Bobina CC	10
Contactores Tripolares de 112 hasta 800 A (AC-3) - Bobina con Módulo Electrónico CA/CC	11
Contactores Tetrapolares - Bobinas CA o con Módulo Electrónico CA/CC	12
Accesorios	13
Repuestos	18
Características Técnicas	19
Dimensiones (mm)	39



Contadores CWM - Introducción

Con capacidad de maniobrar cargas inductivas nominales hasta 800 A o 440 kW @ 380/400 V, WEG puede suministrar el contactor más adecuado para su aplicación.

Contactores CWM permiten optimización total de espacio en el tablero, con solamente algunos tamaños compactos es posible maniobrar potencias de 4 hasta 440 kW @ 400/415 V. Para reducir stock, los contactores CWM poseen accesorios comunes. Por ejemplo, los bloques de contactos auxiliares laterales son los mismos de 9 hasta 300 A (AC-3) @ 440 V.

Desarrollados para tener elevada vida eléctrica y mecánica, pueden ser utilizados en las más severas aplicaciones industriales. Todos los contactores WEG son testeados y aprobados para aplicaciones de acuerdo con las coordinaciones tipo 1 y tipo 2.

Para tener una aceptación global, todos los componentes están de acuerdo a las normas UL 508 (USA y Canadá), IEC/EN 60497 y CE.

Todos los contactores WEG son fabricados con procesos y materiales de alta calidad.

De esta manera, WEG ofrece soluciones para aplicaciones en baja tensión para tableros, fabricantes de equipo original, distribuidores y usuarios.



Contactores CWM desde 9 hasta 40 A (AC-3) - Accesorios

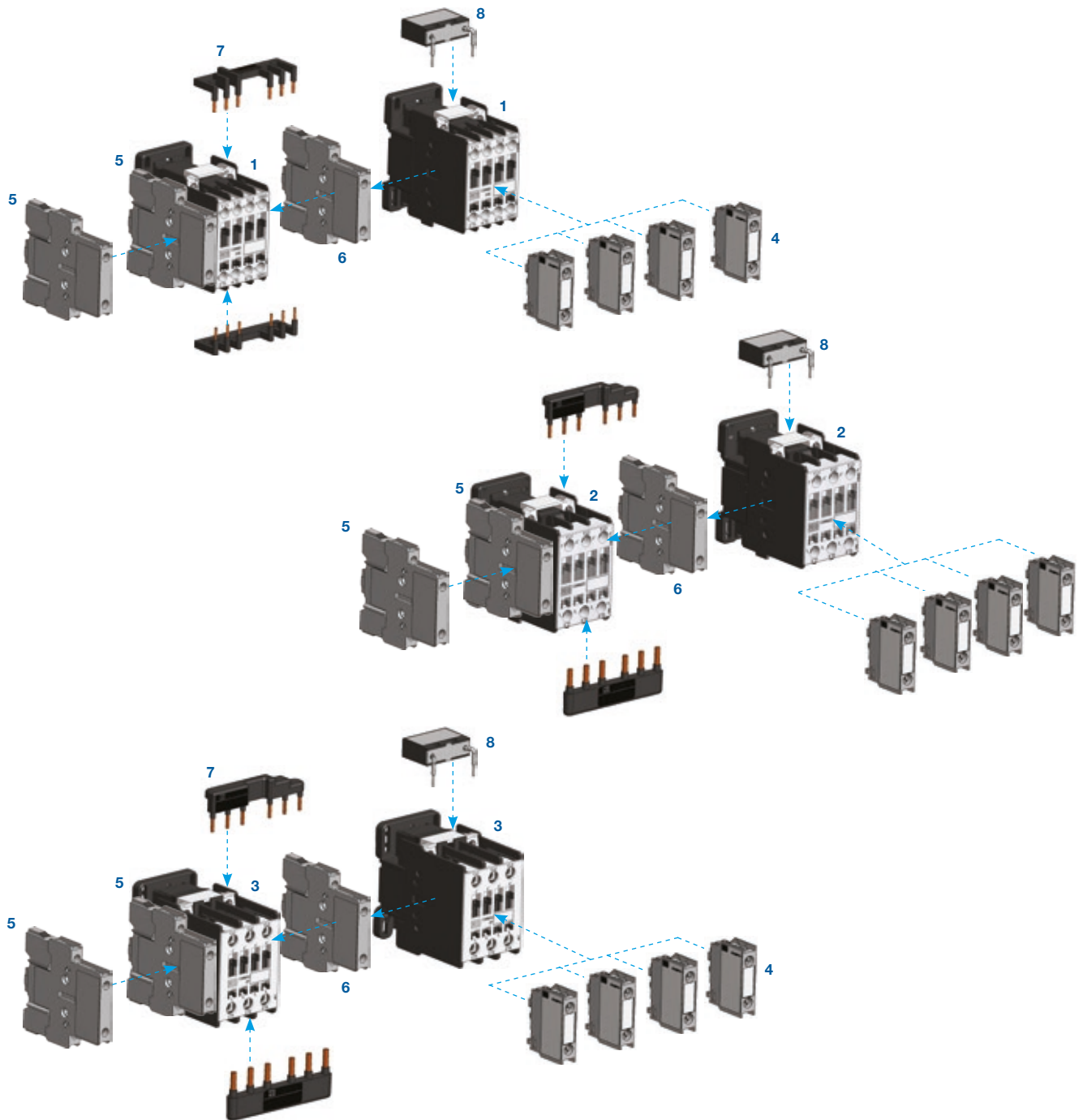

- 1 - Contactores CWM9...18
- 2 - Contactores CWM25
- 3 - Contactores CWM32/40
- 4 - Bloque de contacto auxiliar frontal BCXMF
- 5 - Bloque de contacto auxiliar lateral BCXML
- 6 - Enclavamiento mecánico BLIM
- 7 - Barras easy connection
- 8 - Supresor de sobretensión BAM

Contactores CWM desde 50 hasta 105 A (AC-3) - Accesorios

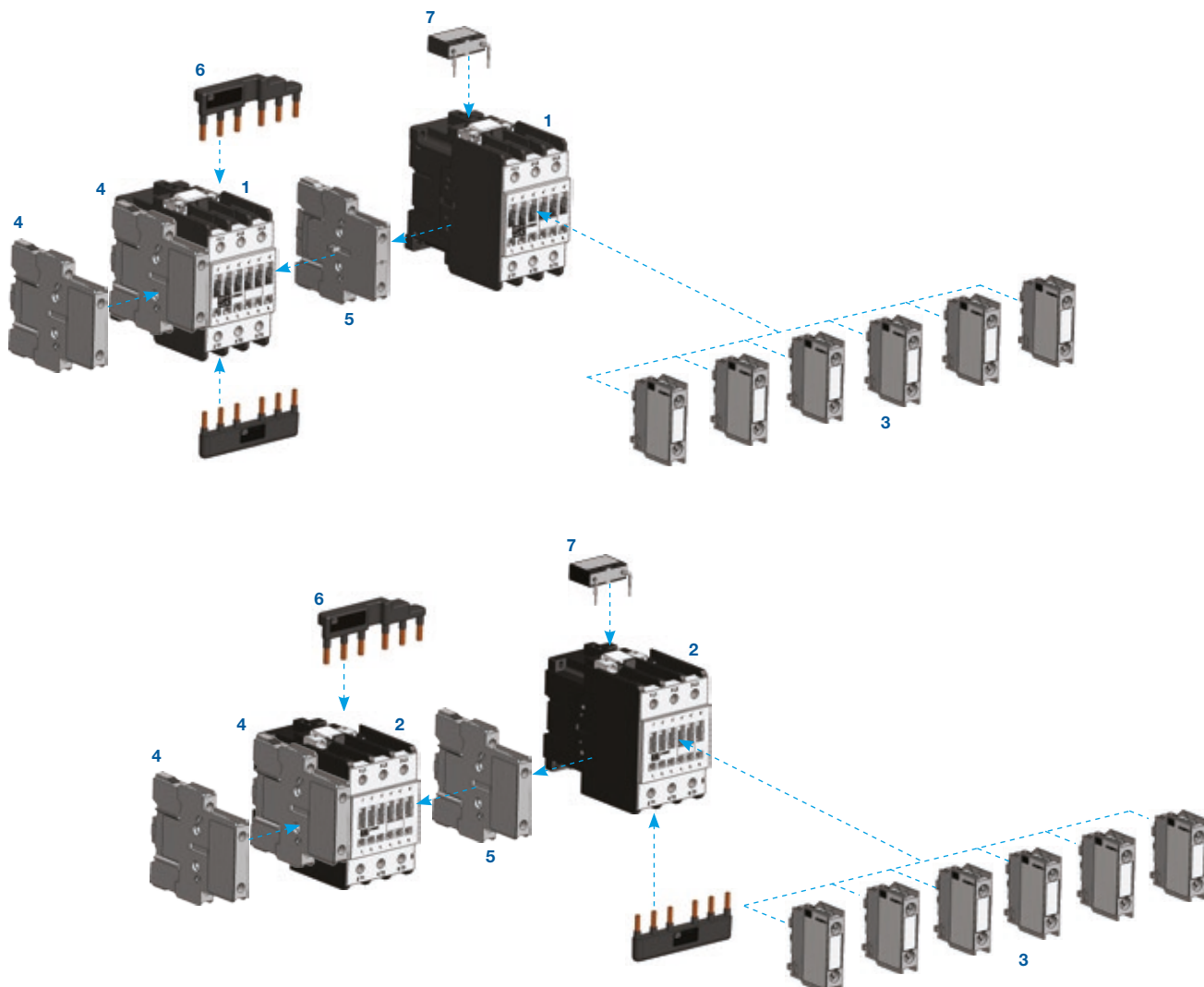

- 1 - Contactores CWM50...80
- 2 - Contactores CWM95/105
- 3 - Bloque de contacto auxiliar frontal BCXMF
- 4 - Bloque de contacto auxiliar lateral BCXML
- 5 - Enclavamiento mecánico BLIM
- 6 - Barras easy connection
- 7 - Supresor de sobretensión BAM

Contadores CWM desde 112 hasta 300 A (AC-3) - Accesorios

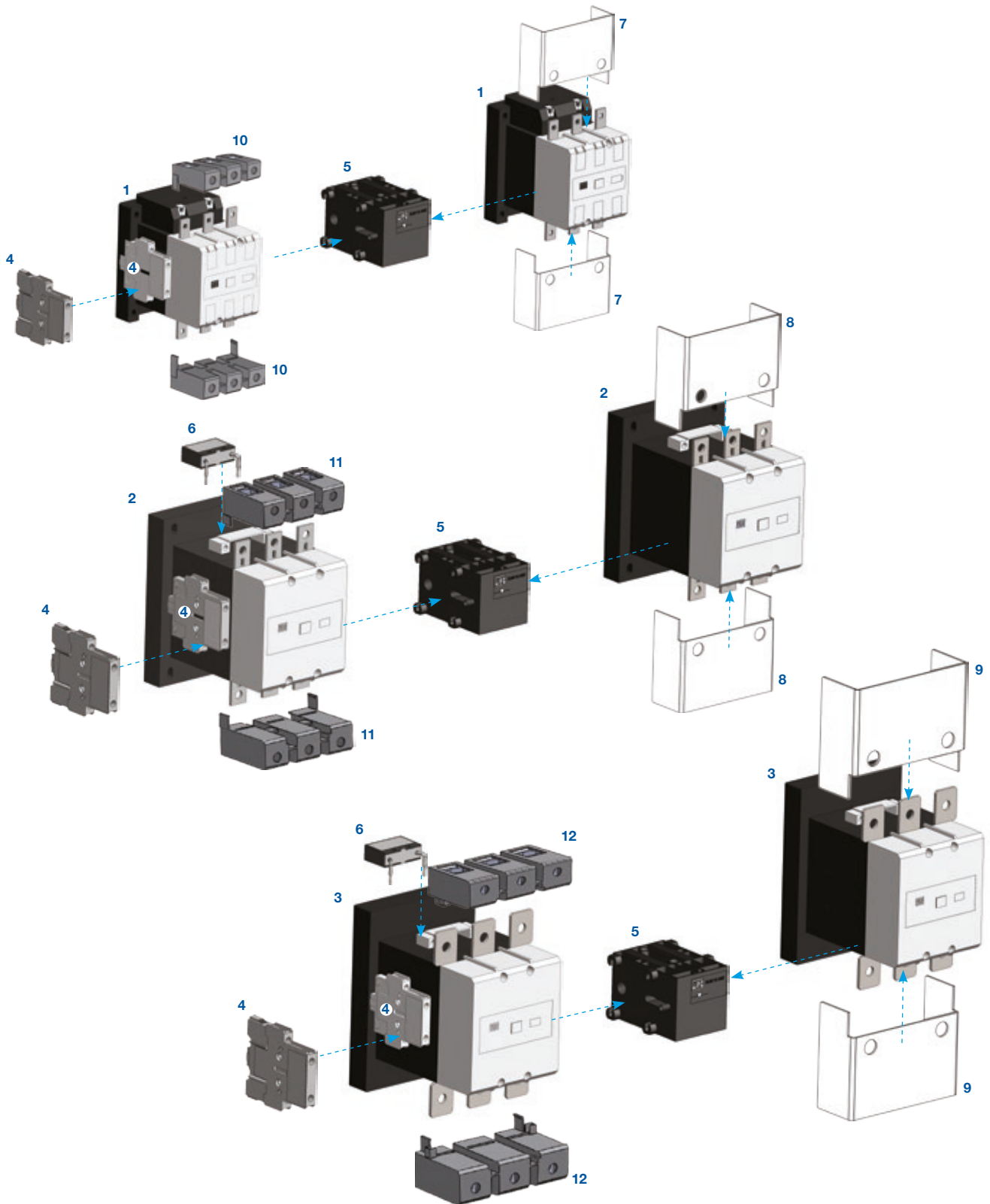

- 1 - Contactores CWM112/150
- 2 - Contactores CWM180
- 3 - Contactores CWM250/300
- 4 - Bloque de contacto auxiliar lateral BCXML
- 5 - Enclavamiento mecánico BLIM112-300
- 6 - Supresor de sobretensión BAMV

- 7 - Cubrebornes BMP CWM150
- 8 - Cubrebornes BMP CWM180
- 9 - Cubrebornes BMP CWM300
- 10 - Bloque prensacable TB150
- 11 - Bloque prensacable TB180
- 12 - Bloque prensacable TB300

Contactores CWM desde 400 hasta 800 A (AC-3) - Accesorios

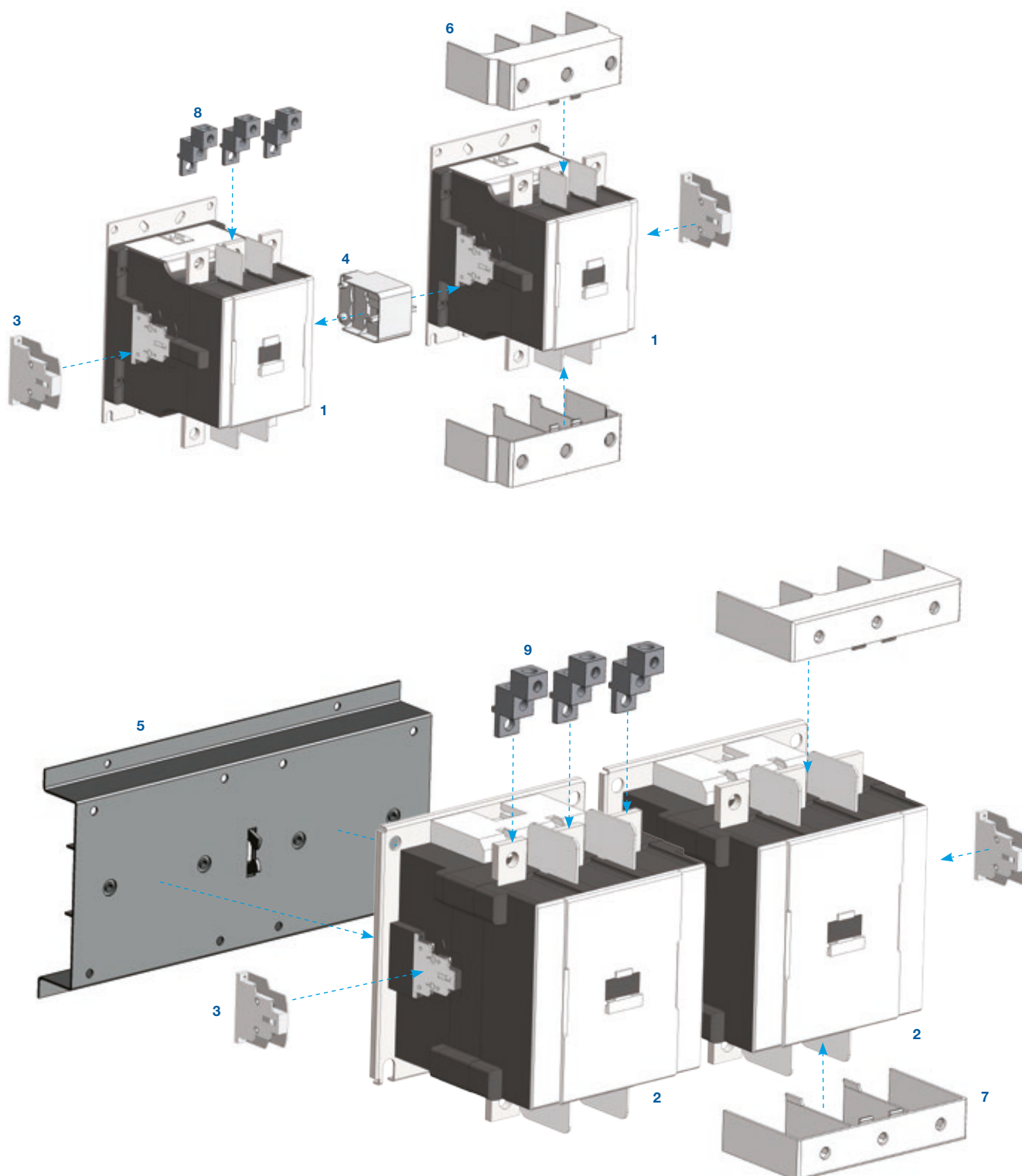

- 1** - Contactores CWM400
- 2** - Contactores CWM500...800
- 3** - Bloque de contactos auxiliares BCXML** CWM800
- 4** - Enclavamiento mecánico BLIM CWM400
- 5** - Enclavamiento mecánico BLIM CWM800
- 6** - Cubrebornes BMP CWM400
- 7** - Cubrebornes BMP CWM800
- 8** - Prensacables BMJ CWM400
- 9** - Prensacables BMJ CWM800

Contadores CWM - Tabla de Selección



Contadores Tripolares de 9 hasta 250 A (AC-3) - Bobina CA³⁾

Corriente nominal de operación I_n AC-3 ($U_n \leq 440$ V)	Corriente térmica convencional $I_{th} = I_n$ AC-1	Potencia nominal máxima de operación motores trifásicos 50/60 Hz ¹⁾						Contactos auxiliares integrados en el contactor		Bloques de contactos auxiliares		Referencia para completar con el código de tensión de mando	Peso kg
		220 V 230 V	380 V	400 V 415 V	440 V	500 V	660 V 690 V	*3 *4 NA	*1 *2 NC	BCXMF10 NA	BCXMF01 NC		
9	25	2,2 / 3	4 / 5	4 / 5	4,5 / 6	4,5 / 6	5,5 / 7,5	1	0	-	-	CWM9-10-30♦	0,360
								0	1	-	-	CWM9-01-30♦	
								1	1	-	1	CWM9-11-30♦	
								2	2	1	2	CWM9-22-30♦	
12	25	3 / 4	5,5 / 7,5	5,5 / 7,5	5,5 / 7,5	5,5 / 7,5	7,5 / 10	1	0	-	-	CWM12-10-30♦	0,360
								0	1	-	-	CWM12-01-30♦	
								1	1	-	1	CWM12-11-30♦	
								2	2	1	2	CWM12-22-30♦	
18	32	4,5 / 6	7,5 / 10	7,5 / 10	9,2 / 12,5	9,2 / 12,5	11 / 15	1	0	-	-	CWM18-10-30♦	0,360
								0	1	-	-	CWM18-01-30♦	
								1	1	-	1	CWM18-11-30♦	
								2	2	1	2	CWM18-22-30♦	
25	45	5,5 / 7,5	11 / 15	11 / 15	11 / 15	11 / 15	11 / 15	0	0	-	-	CWM25-00-30♦	0,390
								1	0	1	-	CWM25-10-30♦	
								0	1	-	1	CWM25-01-30♦	
								1	1	1	1	CWM25-11-30♦	
32	60	9,2 / 12,5	15 / 20	15 / 20	15 / 20	15 / 20	18,5 / 25	2	2	2	2	CWM25-55-30♦	0,620
								0	0	-	-	CWM32-00-30♦	
								1	0	1	-	CWM32-10-30♦	
								0	1	-	1	CWM32-01-30♦	
40	60	11 / 15	18,5 / 25	18,5 / 25	22 / 30	22 / 30	22 / 30	1	1	1	1	CWM32-11-30♦	0,650
								2	2	2	2	CWM32-22-30♦	
								0	0	-	-	CWM40-00-30♦	
								1	1	1	1	CWM40-11-30♦	
50	90	15 / 20	22 / 30	22 / 30	30 / 40	30 / 40	30 / 40	2	2	2	2	CWM40-22-30♦	1,205
								0	0	-	-	CWM50-00-30♦	
								1	1	1	1	CWM50-11-30♦	
								2	2	2	2	CWM50-22-30♦	
65	110	18,5 / 25	30 / 40	30 / 40	37 / 50	37 / 50	37 / 50	0	0	-	-	CWM65-00-30♦	1,215
								1	1	1	1	CWM65-11-30♦	
								2	2	2	2	CWM65-22-30♦	
								0	0	-	-	CWM80-00-30♦	
80	110	22 / 30	37 / 50	45 / 60	45 / 60	45 / 60	45 / 60	1	1	1	1	CWM80-11-30♦	1,220
								2	2	2	2	CWM80-22-30♦	
								0	0	-	-	CWM95-00-30♦	
								1	1	1	1	CWM95-11-30♦	
95	140	22 / 30	45 / 60	55 / 75	55 / 75	55 / 75	55 / 75	2	2	2	2	CWM95-22-30♦	1,525
								0	0	-	-	CWM105-00-30♦	
								1	1	1	1	CWM105-11-30♦	
								2	2	2	2	CWM105-22-30♦	
105	140	30 / 40	55 / 75	55 / 75	55 / 75	55 / 75	55 / 75	2	2	-	-	CWM112-22-30♦	1,505
								0	0	-	-	CWM112-00-30♦	
112	180	30 / 40	55 / 75	55 / 75	55 / 75	55 / 75	75 / 100	2	2	-	-	CWM112-22-30♦	3,1
180	225	55 / 75	90 / 125	90 / 125	110 / 150	110 / 150	110 / 150	2	2	-	-	CWM180-22-30♦	51,0
250	350	75 / 100	132 / 175	132 / 175	150 / 200	160 / 220	160 / 220	2	2	-	-	CWM250-22-30♦	6,66

Reemplazar "♦" con el código de tensión deseado²⁾.

Bobina CA - 50/60 Hz												
Códigos de tensión de bobinas	D02	D07	D13	D23	D24	D25	D33	D34	D35	D36	D39	
V ca - 50/60 Hz	24	48	110	220	230	240	380	400	415	440	480	

Notas: 1) Los dimensionamientos presentados son válidos para motores WEG W22 Plus, IV polos, factor de servicio 1,0 y categoría de servicio AC-3.

Estos valores son orientativos y pueden cambiar de acuerdo con el número de polos o proyecto del motor.



2) Otras tensiones bajo consulta.

3) Para selección de accesorios, consulte la sección "Contactores CWM - accesorios".

Contadores CWM - Tabla de Selección



Contadores Tripolares de 40 hasta 105 A (AC-3) - Bobina CC⁴⁾⁵⁾

Corriente nominal de operación I_e AC-3 ($U_e \leq 440$ V)	Corriente térmica convencional $I_{th} = I_e$ AC-1	Potencia nominal máxima de operación motores trifásicos 50/60 Hz ¹⁾						Contactos auxiliares integrados en el contactor		Bloques de contactos auxiliares		Referencia para completar con el código de tensión de mando	Peso kg
		220 V 230 V	380 V	400 V 415 V	440 V	500 V	660 V 690 V	 NA	 NC	BCXMF10 NA	BCXMF01 NC		
40	60	11 / 15	18,5 / 25	18,5 / 25	22 / 30	22 / 30	22 / 30	0	0	-	-	CWM40-00-30♦	0,640
								1	1	1	1	CWM40-11-30♦	
								2	2	2	2	CWM40-22-30♦	
50	90	15 / 20	22 / 30	22 / 30	30 / 40	30 / 40	30 / 40	0	0	-	-	CWM50-00-30♦	1,463
								1	1	1	1	CWM50-11-30♦	
								2	2	2	2	CWM50-22-30♦	
65	110	18,5 / 25	30 / 40	30 / 40	37 / 50	37 / 50	37 / 50	0	0	-	-	CWM65-00-30♦	1,463
								1	1	1	1	CWM65-11-30♦	
								2	2	2	2	CWM65-22-30♦	
80	110	22 / 30	37 / 50	45 / 60	45 / 60	45 / 60	45 / 60	0	0	-	-	CWM80-00-30♦	1,463
								1	1	1	1	CWM80-11-30♦	
								2	2	2	2	CWM80-22-30♦	
95	140	22 / 30	45 / 60	55 / 75	55 / 75	55 / 75	55 / 75	0	0	-	-	CWM95-00-30♦	1,463
								1	1	1	1	CWM95-11-30♦	
								2	2	2	2	CWM95-22-30♦	
105	140	30 / 40	55 / 75	55 / 75	55 / 75	55 / 75	55 / 75	0	0	-	-	CWM105-00-30♦	1,463
								1	1	1	1	CWM105-11-30♦	
								2	2	2	2	CWM105-22-30♦	

Reemplazar "♦" con el código de tensión deseado²⁾³⁾.

Códigos de tensión de bobinas (CWM40...105)	C34	C37	C40	C44
V cc	24-28	42-50	110-130	208-240

Notas: 1) Los dimensionamientos presentados son válidos para motores WEG W22 Plus, IV polos, factor de servicio 1,0 y categoría de servicio AC-3.

Estos valores son orientativos y pueden cambiar de acuerdo con el número de polos o proyecto del motor.

2) Otras tensiones bajo consulta.

3) No es necesaria la utilización de supresores de sobretensión para contactores CWM40-105 con bobina CC.

4) Para selección de accesorios, consulte la sección "Contactores CWM - Accesorios".

5) Para corrientes menores que 40 A (AC-3) utilizar la nueva línea CWB9...38.

Contadores CWM - Tabla de Selección



Contadores Tripolares de 112 hasta 300 A (AC-3) - Bobina con Módulo Electrónico CA/CC

Corriente nominal de operación I_n AC-3 ($U_e \leq 440$ V)	Corriente térmica convencional $I_{th} = I_n$ AC-1	Potencia nominal máxima de operación motores trifásicos 50/60 Hz ¹⁾						Contactos auxiliares integrados en el contactor (BCXML)		Referencia para completar con el código de tensión de mando	Peso kg
		220 V 230 V	380 V	400 V 415 V	440 V	500 V	690 V	3 4	1 2		
A	A	(kW / HP)	(kW / HP)	(kW / HP)	(kW / HP)	(kW / HP)	(kW / HP)	NA	NC		
112	180	30 / 40	55 / 75	55 / 75	55 / 75	55 / 75	75 / 100	2	2	CWM112-22-30♦	3,12
150	225	45 / 60	75 / 100	75 / 100	90 / 125	90 / 125	110 / 150	2	2	CWM150-22-30♦	3,20
180	225	50 / 75	90 / 125	90 / 125	110 / 150	110 / 150	110 / 150	2	2	CWM180-22-30♦	5,01
250	350	75 / 100	132 / 175	132 / 175	150 / 200	160 / 220	160 / 200	2	2	CWM250-22-30♦	6,86
300	410	90 / 125	150 / 200	160 / 220	185 / 250	200 / 270	200 / 270	2	2	CWM300-22-30♦	6,73

Reemplazar "♦" con el código de tensión deseado²⁾.

Códigos de tensión de bobinas	E02	E06	E07	E10	E13	E16	E21
50/60 Hz / DC ³⁾	24-28 V	42-50 V	60-72 V	110-130 V	208-250 V	360-415 V	430-500 V



Contadores Tripolares de 400 hasta 800 A (AC-3) - Bobina con Módulo Electrónico CA/CC

Corriente nominal de operación I_n AC-3 ($U_e \leq 440$ V)	Corriente térmica convencional $I_{th} = I_n$ AC-1	Potencia nominal máxima de operación motores trifásicos 50/60 Hz ¹⁾						Contactos auxiliares integrados en el contactor (BCXML)		Referencia para completar con el código de tensión de mando	Peso kg
		220 V 230 V	380 V	400 V 415 V	440 V	500 V	690 V	3 4	1 2		
A	A	(kW / HP)	(kW / HP)	(kW / HP)	(kW / HP)	(kW / HP)	(kW / HP)	NA	NC		
400	450	125 / 150	220 / 300	220 / 300	220 / 300	220 / 300	250 / 330	2	2	CWM400-22-30♦	9,2
500	580	150 / 200	265 / 355	265 / 355	265 / 355	265 / 355	300 / 400	2	2	CWM500-22-30♦	22,4
630	660	190 / 250	330 / 450	330 / 450	330 / 450	330 / 450	330 / 450	2	2	CWM630-22-30♦	23,2
800	900	220 / 300	440 / 600	440 / 600	440 / 600	500 / 700	500 / 700	2	2	CWM800-22-30♦	23,3

Reemplazar "♦" con el código de tensión deseado²⁾.

Códigos de tensión de bobinas (CWM400)	E36	D80	D81	D82
50/60 Hz / CC ³⁾	100-240 V ca / 100-220 V cc	-	-	-
50/60 Hz ³⁾	-	265-347 V	380-450 V	440-575 V

Códigos de tensión de bobinas (CWM500/630/800)	E35	E39	D80	D81	D82
50/60 Hz / CC ³⁾	100-127 V ca / 100-110 V cc	200-240 V ca / 200-220 V cc	-	-	-
50/60 Hz ³⁾	-	-	265-347 V	380-450 V	440-575 V

Notas: 1) Los dimensionamientos presentados son válidos para motores WEG W22 Plus, 4V polos, factor de servicio 1,0 y categoría de servicio AC-3.

Estos valores son orientativos y pueden cambiar de acuerdo con el número de polos o proyecto del motor.

2) Otras tensiones bajo consulta.

3) Supresor de surto ya está integrado.

Contadores CWM - Tabla de Selección



Contadores Tetrapolares de 25 hasta 32 A (AC-1)

$I_e = I_n$ $(U_e \leq 690 \text{ V})$ $\theta \leq 55 \text{ }^\circ\text{C}$ AC-1 A	Numero de polos		Referencia para completar con el código de tensión de mando	Peso kg
	$\begin{array}{c} \cdot 3 \\ \\ \cdot 4 \\ \text{NA} \end{array}$	$\begin{array}{c} \cdot 1 \\ \\ \cdot 2 \\ \text{NC} \end{array}$		
25	2	2	CWM9-00-22 ♦	0,360
	4	-	CWM9-00-40 ♦	
25	2	2	CWM12-00-22 ♦	0,360
	4	-	CWM12-00-40 ♦	
32	2	2	CWM18-00-22 ♦	0,360
	4	-	CWM18-00-40 ♦	

Reemplazar "♦" con el código de tensión deseado¹⁾.

Bobina CA - 50/60 Hz											
Códigos de tensión de bobinas	D02	D07	D13	D23	D24	D25	D33	D34	D35	D36	D39
V ca - 50/60 Hz	24	48	110	220	230	240	380	400	415	440	480

Contadores Tetrapolares de 420 hasta 800 A (AC-1)

Corriente térmica convencional I_n (55 °C) A	Corriente AC-1 A	Potencia AC-1				Contactos auxiliares integrados por contactor (BCXML)		Referencia para completar con el código de tensión de mando	Peso kg
		220 V 240 V kW	380 V 400 V kW	500 V 550 V kW	690 V kW	$\begin{array}{c} \cdot 3 \\ \\ \cdot 4 \\ \text{NA} \end{array}$	$\begin{array}{c} \cdot 1 \\ \\ \cdot 2 \\ \text{NC} \end{array}$		
500	420	160	300	375	470	2	2	CWM400-22-40 ♦	9,9
630	630	245	450	560	710	2	2	CWM500-22-40 ♦	26,3
750	660	255	470	590	740	2	2	CWM630-22-40 ♦	26,3
900	800	310	570	710	900	2	2	CWM800-22-40 ♦	26,3

Reemplazar "♦" con el código de tensión deseado¹⁾.

Códigos de tensión de bobinas (CWM400)	E36	D81
50/60 Hz / CC ²⁾	100-240 V ca / 100-220 V cc	-
50/60 Hz ²⁾	-	380-450 V















Códigos de tensión de bobinas (CWM500/630/800)	E35	E39
50/60 Hz / CC ²⁾	100-127 V ca / 100-110 V cc	200-240 V ca / 200-220 V cc

Notas: 1) Otras tensiones bajo consulta.
2) Supresor de surto ya está integrado.

Contadores CWM - Accesorios

Bloques de Contactos Auxiliares

- Contactos positivamente guiados de acuerdo con IEC/EN 60947-4-1 y IEC/EN 60947-5-1
- Marcación de los terminales: EN 50 005 y EN 50 012

Foto ilustrativa	Para uso con	Num. máx. de contactos adicionales / contactor	Contactos auxiliares		Marcación de terminales	Referencia	Peso kg
			NA	NC			
	CWM9...105	4 / CWM9...25	1	0		BCXMF10	0,015
			1	0		BCXMF10-AU ⁶⁾	
			0	1		BCXMF01	
			0	1		BCXMF01-AU ⁶⁾	
			1 ¹⁾	0		BCXMF A10	
			0	1 ²⁾		BCXMF R01	
	CWM9...300	8 / CWM50...105	2	0		BCXML20	0,050
		8 / CWM112...300	1	1		BCXML11	
			2	0		BCXMRL20 ³⁾	
			1	1		BCXMRL11 ³⁾	
	CWM400...800	8 / CWM400...800	1	1		BCXML11 CWM800	0,045
						BCXML11 CWM800 ³⁾	

Enclavamiento Mecánico para Contactores⁵⁾

Foto ilustrativa	Para uso con	Referencia	Peso kg
	CWM9...CWM105	BLIM9-105	0,050
		BLIM.02 ⁴⁾	
	CWM112...CWM300	BLIM112-300	0,150
	CWM400	BLIM CWM400	0,100
	CWM500...800 - 3 poles	BLIM CWM800	15,0
	CWM500...800 - 4 poles	BLIM CWM800-4P	16,0

Notas: 1) Contacto abierto adelantado.

2) Contacto cerrado retrasado.

3) Para combinaciones de dos bloques de contactos auxiliares laterales en el mismo lado del contactor.

4) Accesorio permite enclavamiento eléctrico y mecánico.

5) Aplicable solamente para contactores de mismo tamaño.

6) Bloque de contacto especial para corriente muy baja (1 mA / 17 V).

Contadores CWM - Accesorios

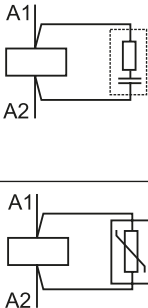

Supresores de Surto

- Conexión directa en los terminales A1 y A2 de la bobina

Foto ilustrativa	Para uso con	Tensión	Diagrama	Referencia	Peso kg
	CWM9...40	24 - 48 V 50/60 Hz		BAMRC4 D53	0,014
		50 - 127 V 50/60 Hz		BAMRC5 D55	
		130 - 250 V 50/60 Hz		BAMRC6 D63	
	CWM50...105	24 - 48 V 50/60 Hz		BAMRC7 D53	
		50 - 127 V 50/60 Hz		BAMRC8 D55	
		130 - 250 V 50/60 Hz		BAMRC9 D63	
	CWM112...250	24 - 48 V 50/60 Hz		BAMRC13 D53	
		50 - 250 V 50/60 Hz		BAMRC14 D56	
	CWM9...105	270 - 380 V 50/60 Hz		BAMV1 D68	
		400 - 510 V 50/60 Hz		BAMV2 D73	
	CWM112...250	270 - 380 V 50/60 Hz		BAMV3 D68	
		400 - 510 V 50/60 Hz		BAMV4 D73	

Cubrebornes

- Protección contra contactos de acuerdo con reglas de seguridad

Foto ilustrativa	Para uso con	Descripción	Referencia	Peso kg
	CWM112/150	1 kit con 2 piezas ¹⁾	BMP CWM150	0,10
	CWM180		BMP CWM180	0,15
	CWM250/300		BMP CWM300	0,20
	CWM112/150	1 kit con 1 pieza ¹⁾	BMP1 CWM150	0,05
	CWM180		BMP1 CWM180	0,08
	CWM250/300		BMP1 CWM300	0,10
	CWM400 (3 polos)	1 kit con 2 piezas ¹⁾	BMP CWM400	0,12
	CWM500...800 (3 polos)		BMP CWM800	0,28
	CWM400 (4 polos)		BMP CWM400-4P	0,16
	CWM500...800 (4 polos)		BMP CWM800-4P	0,37

Bloque de Prensacables²⁾

Foto ilustrativa	Para uso con	Cables flexibles	Par de apriete	Descripción	Referencia	Peso kg
	CWM112/150	25...70 mm ² 3...2/0 AWG	14 N.m	1 pieza de 3 polos	TB150	0,29
	CWM180	50...120 mm ² 1/0...250 kcmil AWG	14 N.m		TB180	0,35
	CWM250/300	50...150 mm ² 1/0...300 kcmil AWG	20 N.m		TB300	0,45

Prensacables

Foto ilustrativa	Para uso con	Descripción	Referencia	Peso kg
	CWM400	1 kit con 3 piezas	BMJ CWM400	0,495
	CWM500...800	1 kit con 3 piezas	BMJ CWM400	1,0

Notas: 1) Cada pieza hace la protección de 3 terminales.

2) Grado de protección IP20 para contactos frontales.

Contadores CWM - Accesorios

Barras para Arranque Reverso¹⁾

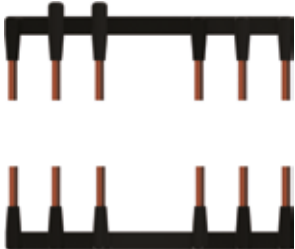
Foto ilustrativa	Corriente nominal de operación I _e AC - 3 (U _e ≤ 440 V) A	Potencia nominal de operación máx. motores trifásicos 50/60 Hz			Contadores	Referencia	Peso kg
		220-230 V kW / HP	400-415 V kW / HP	660-690 V kW / HP			
	9	2,2 / 3	4 / 5	5,5 / 7,5	K1 = K2 CWM9	EC-R-7,5	0,033
	12	3 / 4	5,5 / 7,5	7,5 / 10	CWM12		
	18	4,5 / 6	7,5 / 10	11 / 15	CWM18		
	25	5,5 / 7,5	11 / 15	11 / 15	CWM25	EC-RC-11	0,5
	32	9,2 / 12,5	15 / 20	18,5 / 25	CWM32		
	40	11 / 15	18,5 / 25	22 / 30	CWM40		
	50	15 / 20	22 / 30	30 / 40	CWM50		
	65	18,5 / 25	30 / 40	37 / 50	CWM65		
	80	22 / 30	45 / 60	45 / 60	CWM80		



Diagrama eléctrico

Barras para Arranque Estrella-Triángulo¹⁾

Foto ilustrativa	Corriente nominal de operación I _e AC - 3 (U _e ≤ 440 V) A	Potencia nominal de operación máx. motores trifásicos 50/60 Hz			Contadores		Referencia	Peso kg
		220-230 V kW / HP	400-415 V kW / HP	660-690 V kW / HP	K1 = K2	K3		
	25	5,5 / 7,5	11 / 15	18,5 / 25	CWM18	CWM9	EC-SD-15	0,051
	32	7,5 / 10	15 / 20	18,5 / 25	CWM18	CWM12		
	40	7,5 / 10	18,5 / 25	22 / 30	CWM25	CWM18	EC-SD-22	0,5
	50	11 / 15	22 / 30	22 / 30	CWM25	CWM18		
	54	15 / 20	22 / 30	30 / 40	CWM32	CWM18	EC-SD-25	
	60	15 / 20	30 / 40	37 / 50	CWM40	CWM25	EC-SD-30	
	80	18,5 / 25	37 / 50	45 / 60	CWM50	CWM25	EC-SD-37	
	85	22 / 30	45 / 60	55 / 75	CWM50	CWM32	EC-SD-55	
	105	30 / 40	55 / 75	55 / 75	CWM65	CWM40	EC-SD-75	
	138	37 / 50	75 / 100	75 / 100	CWM80	CWM50		
	140	37 / 50	75 / 100	90 / 125	CWM95	CWM50		
	175	45 / 60	90 / 125	110 / 150	CWM105	CWM65	EC-SD-90	



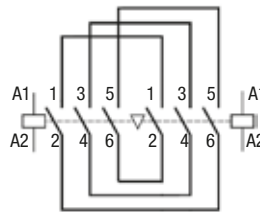
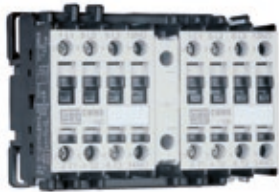
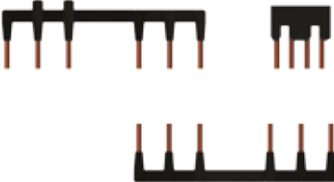

Diagrama eléctrico

Barra Tripolar (k3) para Arranadores Estrella-Triángulo

Foto ilustrativa	Para usar con	Description	Referencia	Peso kg
	CWM9...18	Barra tripolar para conectar en paralelo bornes L1-L2-L3 de contactor K3 en un arranque estrella-triángulo	SBCM9-18	0,006
	CWM25		SBCM25	0,006
	CWM32/40		SBCM32-40	0,015
	CWM50/65		SBCM50-65	0,031

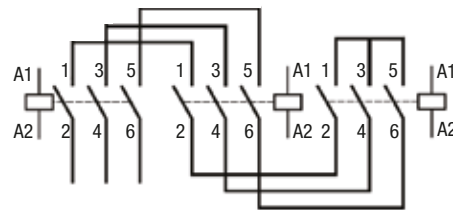
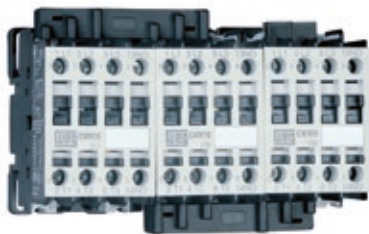
Nota: 1) Contactores y enclavamiento mecánico se venden por separado.

Contadores CWM - Accesorios

Componentes Individuales para Arranadores Reversibles

Potencia nominal de operación máx. motores trifásicos 50/60 Hz				Componentes individuales para arranque reverso					
220-230 V (kW / HP)	400 -415 V (kW / HP)	500 V (kW / HP)	660-690 V (kW / HP)	Contactor K1	Contactor K2	Contactos auxiliares		Enclavamiento mecánico	Kit de barras
				Tipo	Tipo	K1	K2		
2,2 / 3	4 / 5	4,5 / 6	5,5 / 7,5	CWM9-11	CWM9-11	-	-	BLIM9-105	EC-SD...
3 / 4	5,5 / 7,5	5,5 / 7,5	7,5 / 10	CWM12-11	CWM12-11	-	-		
4,5 / 6	7,5 / 10	9,2 / 12,5	11 / 15	CWM18-11	CWM18-11	-	-		
5,5 / 7,5	11 / 15	11 / 15	11 / 15	CWM25-11	CWM25-11	-	-		
9,2 / 12,5	15 / 20	15 / 20	18,5 / 25	CWM32-11	CWM32-11	-	-		
11 / 15	18,5 / 25	22 / 30	22 / 30	CWM40-11	CWM40-11	-	-		
15 / 20	22 / 30	30 / 40	30 / 40	CWM50-11	CWM50-11	-	-		
18,5 / 25	30 / 40	37 / 50	37 / 50	CWM65-11	CWM65-11	-	-		
22 / 30	45 / 60	45 / 60	45 / 60	CWM80-11	CWM80-11	-	-		
22 / 30	55 / 75	55 / 75	55 / 75	CWM95-11	CWM95-11	-	-		
30 / 40	55 / 75	55 / 75	55 / 75	CWM105-11	CWM105-11	-	-		
30 / 40	55 / 75	55 / 75	75 / 100	CWM112-22	CWM112-22	1NA/1NC	1NA/1NC	BLIM112-300	-
45 / 60	75 / 100	90 / 125	110 / 150	CWM150-22	CWM150-22	1NA/1NC	1NA/1NC		
55 / 75	90 / 125	110 / 150	110 / 150	CWM180-22	CWM180-22	1NA/1NC	1NA/1NC		
75 / 100	132 / 175	160 / 220	160 / 220	CWM250-22	CWM250-22	1NA/1NC	1NA/1NC		
90 / 125	160 / 220	200 / 270	200 / 270	CWM300-22	CWM300-22	1NA/1NC	1NA/1NC		

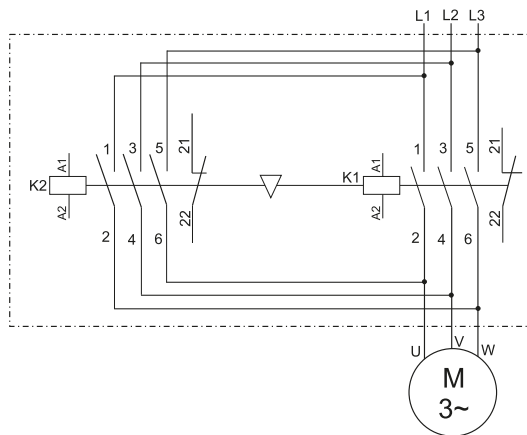
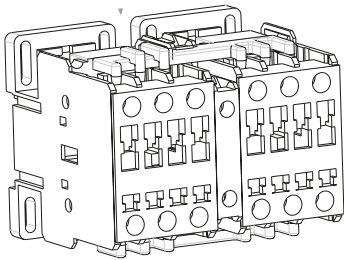

Arranques reversos

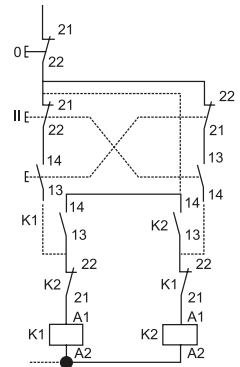

Contadores CWM - Accesorios

Componentes Individuales para Arrancadores Estrella-Triángulo

Potencia máxima nominal de operación motores trifásicos 50/60 Hz				Componentes individuales para arrancadores estrella-triángulo							
220-230 V (kW / HP)	400-415 V (kW / HP)	500 V (kW / HP)	660-690 V (kW / HP)	Contactor principal K1	Contactor triángulo K2	Contactor estrella K3	Temporizador	Contactos auxiliares			Kit de barras
				Referencia	Referencia	Referencia		K1	K2	K3	
5,5 / 7,5	11 / 15	15 / 20	18,5 / 25	CWM18-10 + BCXMF10	CWM18-11	CWM9-11	RTW-ET...	-	-	-	EC-SD...
7,5 / 10	15 / 20	15 / 20	18,5 / 25	CWM18-10 + BCXMF10	CWM18-11	CWM12-11		-	-	-	
7,5 / 10	18,5 / 25	22 / 30	22 / 30	CWM25-00 + 2 x BCXMF10	CWM25-11	CWM18-11		-	-	-	
11 / 15	22 / 30	22 / 30	22 / 30	CWM25-00 + 2 x BCXMF10	CWM25-11	CWM18-11		-	-	-	
15 / 20	30 / 40	37 / 50	37 / 50	CWM40-00 + 2 x BCXMF10	CWM40-11	CWM25-11		-	-	-	
18,5 / 25	37 / 50	37 / 50	45 / 60	CWM50-00 + 2 x BCXMF10	CWM50-11	CWM25-11		-	-	-	
22 / 30	45 / 60	45 / 60	55 / 75	CWM50-00 + 2 x BCXMF10	CWM50-11	CWM32-11		-	-	-	
30 / 40	55 / 75	55 / 75	55 / 75	CWM65-00 + 2 x BCXMF10	CWM65-11	CWM40-11		-	-	-	
37 / 50	75 / 100	75 / 100	90 / 125	CWM95-00 + 2 x BCXMF10	CWM95-11	CWM50-11		-	-	-	
45 / 60	90 / 125	110 / 150	110 / 150	CWM105-00 + 2 x BCXMF10	CWM105-11	CWM65-11		-	-	-	
55 / 75	110 / 150	110 / 150	132 / 175	CWM150-22	CWM150-22	CWM65-11		2NC	1NA/NC	-	
75 / 100	132 / 175	132 / 175	132 / 175	CWM180-22	CWM180-22	CWM80-11		2NC	1NA/NC	-	
90 / 125	160 / 220	160 / 220	200 / 300	CWM250-22	CWM250-22	CWM105-11		2NC	1NA/NC	-	
110 / 150	200 / 270	250 / 330	-	CWM300-22	CWM300-22	CWM150-22		2NC	1NA/NC	1NA/NC	

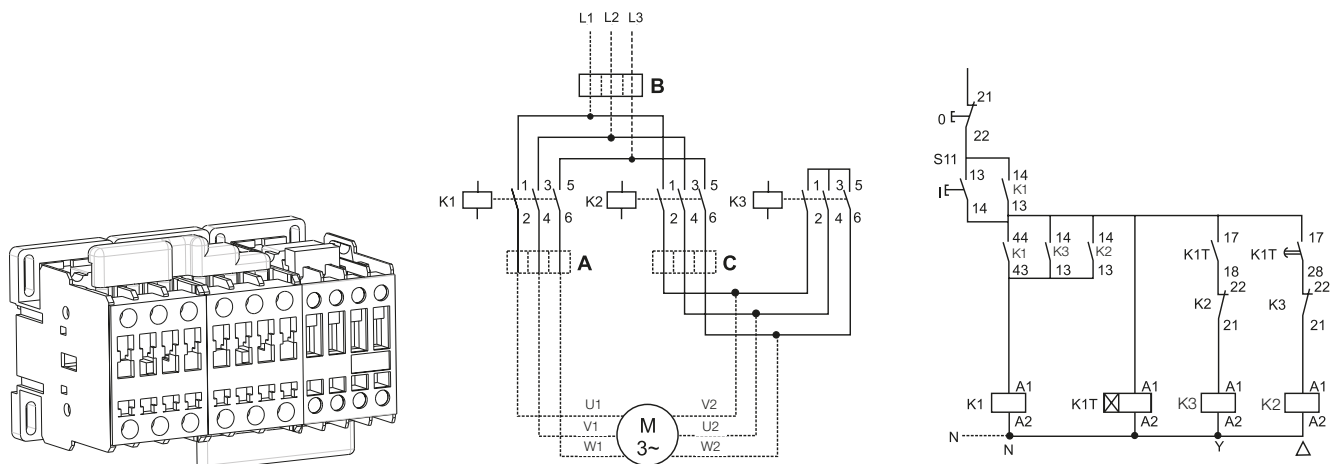

A: $0,58 \times I_r$, protección del motor en la posición estrella y triángulo
 B: $1 \times I_r$, solamente protección parcial del motor en la posición estrella
 C: $0,58 \times I_r$, motor no protegido en la posición estrella

Contadores CWM - Repuesto

Bobinas Individuales

Foto ilustrativa	Descripción	Para uso con	Referencia	Peso kg
	Bobina CA	CWM9...25	BCA4-25♦	0,065
		CWM32...40	BCA4-40♦	0,110
		CWM50...105	BCA-105♦	0,140
		CWM112	BCA-112♦	0,235
		CWM180	BCA-180♦	0,400
		CWM250	BCA-250♦	0,675
	Bobina CC	CWM40	BECC4-40♦	0,180
		CWM50...105	BECC-105♦	0,220
	Bobina doble tensión CA/CC (contactores con módulo electrónico)	CWM112...150	BCE-150♦	0,235
		CWM180	BCE-215♦	0,400
		CWM250...300	BCE-300♦	0,675
		CWM400	BCE400♦ ¹⁾	1,0
		CWM500...800	BCE800♦ ¹⁾	

Módulo Electrónico

Foto ilustrativa	Tipo controle	Para uso con	Referencia	Peso kg
	CA/CC	CWM112...300	ME-300♦ ³⁾	0,140

Reemplazar “♦” con el código de tensión deseado²⁾.

Contadores CWM9...300

Códigos de tensión de bobinas (CWM9...250)	D02	D07	D13	D24	D25	D34	D35
50/60 Hz	24 V	48 V	110 V	230 V	240 V	400 V	415 V
Códigos de tensión de bobinas (CWM40...105)	C34	C37	C40	C44			
V cc	24-28 V	42-50 V	110-130 V	208-240 V			
Códigos de tensión de bobinas (CWM112...300)	E02	E06	E07	E10	E13	E16	E21
50/60 Hz / CC ⁴⁾	24-28 V	42-50 V	60-72 V	110-130 V	208-250 V	360-415 V	430-500 V

Contadores CWM400...800

Códigos de tensión de bobinas (CWM400)	E36	D80	D81	D82	
50/60 Hz / CC ⁴⁾	100-240 V ca / 100-220 V cc	-	-	-	
50/60 Hz ⁴⁾	-	265-347 V	380-450 V	440-575 V	
Códigos de tensión de bobinas (CWM500...800)	E35	E39	D80	D81	D82
50/60 Hz / CC ⁴⁾	100-127 V ca / 100-110 V cc	200-240 V ca / 200-220 V cc	-	-	-
50/60 Hz ⁴⁾	-	-	265-347 V	380-450 V	440-575 V

Notas: 1) Bobina integrada con módulo electrónico.

2) Otras tensiones bajo consulta.

3) La tensión de la bobina debe ser la misma del Módulo ME elegido.

4) Supresor de surto ya está integrado.

Contadores CWM - Características Técnicas

Datos Generales

Referencia	CWM	9	12	18	25	32	40	50	65	80	95	105	112	150	180	250	300	
Normas		IEC/EN 60 947, UL											IEC/EN 60 947					
Tensión nominal de aislamiento U_i IEC/EN 60 947 UL		1.000 V 600 V																
Tensión soportados a los impulsos U_{imp}		6 kV						8 kV										
Frecuencia nominal de operación		25 - 400 Hz																
Grado de protección		Protección contra contacto directo frontal cuando actuado por un dedo de ensayo perpendicular (IEC 536)																
Circuitos principales		IP20			IP10									IP00				
Circuitos de control y contactos auxiliares		IP20																
Temperatura ambiente																		
Temperatura de operación		-25 °C to +55 °C																
Temperatura de almacenado		-55 °C to +80 °C																
Altitud		Hasta 3.000 m																
Valores normales		3.000 hasta 4.000 m																
90% I_g / 80% U_g		4.000 hasta 5.000 m																
80% I_g / 75% U_g																		
Categoría de sobretensión / grado de polución		III / 3																
Protección a la intemperie		Acc. IEC 60680-2																
Numero de polos de los circuitos principales		3																
Tensión nominal de operación U_g		690 V						1.000 V										
Vida mecánica	Ops x 10 ⁶	10																
Vida eléctrica (AC - 3)	Ops x 10 ⁶	1,5	1,2			1,1						1,0						
Montaje		Tornillo o riel DIN 35 mm (DIN EN 50022)													Tornillo			

Circuito de Control

Referencia	CWM	9	12	18	25	32	40	50	65	80	95	105	112	150	180	250	300		
Tensión nominal de aislamiento U_i	IEC/EN	1.000 V																	
	UL	600 V																	
Tensiones nominales (bobina estándar)	Us 50/60 Hz	12...660 V											12...550 V	-	24...690		-		
Tensiones nominales (bobina con módulo electrónico)	Us 50/60 Hz	-											24...500 V						
Tensiones nominales	Us CC	-			24...240 V									24...500 V					
Tiempo de operación ¹⁾	Cerrando/apertura (CA) ms	8...20 / 6...13			10...19 / 5...25			15...30 / 9...15						60...70 / 13...17					
	Cerrando/apertura (CC) ms	-			50...60 / 55...60									60...70 / 13...17			60...70 / 15...25		
Consumo de la bobina CA, 50/60 Hz ¹⁾																			
Cerrando	(VA)	69,5			98			255						590	759	1.104			
	cos φ	0,85			0,69			0,32						0,43	0,14	0,16			
Régimen	(VA)	4...7,2			6,6...12,3			13,1...19,1						28...41	37...52	70...105			
	cos φ	0,28			0,34			0,54						0,31	0,39	0,36			
Límites de operación de la bobina 50/60 Hz ¹⁾																			
Bobinas doble frecuencia ¹⁾	Cerrando	0,5...0,8			0,5...0,8			0,5...0,8						0,7...0,85	0,7...0,85	0,7...0,85			
	Régimen	0,2...0,6			0,2...0,6			0,25...0,6						0,4...0,6	0,4...0,6	0,4...0,6			
Consumo de la bobina, bobinas CC																			
Cerrando	(W)	-			240			340						403	529	644			
Régimen	(W)	-			6			6,5						11	14,3	24,2			
Numero de terminales	Bobina CA	4			4			3						2					
	Bobina CC	-			4			3						2					

Nota: 1) Valores aplicados para contactores CWM112...300 con módulo electrónico. Informaciones para contactores con bobina estándar solamente bajo consulta.

Contadores CWM - Características Técnicas

Contactos Principales

Referencia	CWM9	CWM12	CWM18	CWM25	CWM32	CWM40	CWM50	CWM65	CWM80	CWM95	CWM105	CWM112	CWM150	CWM180	CWM250	CWM300		
Corriente nominal de operación I_n	AC-3 ($U_n \leq 440$ V) (A)	9	12	18	25	32	40	50	65	80	95	105	112	150	180	250	300	
	AC-4 ($U_n \leq 440$ V) (A)	5	7	8	12	16	18,5	23	30	37	44	50	61	66	74	104	132	
	AC-1 ($\theta \leq 55$ °C, $U_n \leq 690$ V) (A)	25	25	32	45	60	60	90	110	110	140	140	180	225	225	350	410	
Tensión nominal de operación U_n	IEC/EN 60947-4-1 (V)	690						1.000										
	UL (V)	600						600										
Corriente térmica convencional I_{th} ($\theta \leq 55$ °C)	(A)	25	25	32	45	60	60	90	110	110	140	140	180	225	225	350	410	
Capacidad de conexión - IEC/EN 60947	(A)	300	300	300	450	550	550	1.000	1.000	1.000	1.280	1.280	1.430	1.820	2.100	2.600	3.000	
Capacidad de desconexión	($U_n \leq 400$ V) (A)	250	250	250	350	450	450	920	920	920	1.050	1.050	1.290	1.350	1.400	2.000	-	
	($U_n = 500$ V) (A)	250	250	250	320	450	450	920	920	920	1.050	1.050	1.290	1.350	1.400	2.000	-	
	($U_n = 690$ V) (A)	130	130	130	170	205	205	780	780	780	950	950	-	-	-	-	-	
Corriente de corta duración sin corriente durante el tiempo de enfriamiento de 10min y $\theta \leq 40$ °C)	1s (A)	455	455	570	630	1.010	1.265	1.580	2.530	2.530	3.300	3.300	3.165	3.763	4.649	4.427	-	
	5s (A)	205	205	254	280	450	450	710	1.130	1.130	1.485	1.485	1.820	2.164	2.673	2.546	-	
	10s (A)	144	144	180	200	320	400	500	800	800	1.050	1.050	1.430	1.700	2.100	2.000	-	
	30s (A)	85	85	104	115	185	230	290	460	460	600	600	826	980	1.212	1.155	-	
	1min (A)	60	60	74	80	130	165	205	325	325	430	430	584	694	857	816	-	
	3min (A)	35	35	46	50	90	100	120	185	185	250	250	337	401	495	471	-	
Protección contra cortocircuitos con fusibles (gL/gG)	@ 600 V - UL (kA)	5						10						18				
	Coordination type 1 (A)	50	50	63	63	100	125	200	200	200	250	250	-	355	355	500	630	
	Coordination type 2 (A)	25	35	35	50	63	80	100	125	125	160	200	224	250	250	400	500	
Impedancia por polo	(mΩ)	2,4	2,4	2,4	1,7	1,3	1,0	0,9	0,9	0,9	0,8	0,8	0,5	0,5	0,45	0,3	0,3	
Disipación de potencia por polo	AC-1 (W)	1,5	1,5	2,5	3,3	4,6	3,4	6,7	10,4	10,4	14,9	14,9	16	25	21,6	35	45,7	
	AC-3 (W)	0,2	0,3	0,8	1,0	1,3	1,5	2,1	3,6	5,5	6,9	8,4	6,2	11,1	13,8	17,9	25,7	
Categoría de servicio AC-3																		
Corriente nominal de operación I_n ($\theta \leq 55$ °C)	$U_n \leq 440$ V (A)	9	12	18	25	32	40	50	65	80	95	105	112	150	180	250	300	
	$U_n \leq 500$ V (A)	7,5	10,5	14	19	24	32	38	55	63	79	85	95	130	155	220	265	
	$U_n \leq 690$ V (A)	7	9	13	15	22	25	34	44	48	60	67	82	110	135	185	220	
	$U_n \leq 1.000$ V (A)	No disponible						19	25	30	37	40	42	48	68	103	126	
Potencia nominal de operación	220 / 230 V	(kW)	2,2	3	4,5	5,5	9,2	11	15	18,5	22	22	30	30	45	55	75	90
		(HP)	3	4	6	7,5	12,5	15	20	25	30	30	40	40	60	75	100	125
	380 / V	(kW)	3,7	5,5	7,5	11	15	18,5	22	30	37	45	55	55	75	90	132	150
		(HP)	5	7,5	10	15	20	25	30	40	50	60	75	75	100	125	175	200
	400 / 415 V	(kW)	3,7	5,5	7,5	11	15	18,5	22	30	37	45	55	55	75	110	132	150
		(HP)	5	7,5	10	15	20	25	30	40	50	60	75	75	100	150	175	200
	440 V	(kW)	4,5	5,5	9,2	11	15	22	30	37	45	55	55	90	110	150	185	
		(HP)	6	7,5	12,5	15	20	30	40	50	60	75	75	125	150	200	250	
	500 V	(kW)	4,5	5,5	9,2	11	15	22	30	37	45	55	55	90	110	150	185	
		(HP)	6	7,5	12,5	15	20	30	40	50	60	75	75	125	150	200	250	
	660 / 690 V	(kW)	5,5	7,5	11	11	18,5	22	30	37	45	55	55	75	110	110	150	185
		(HP)	7,5	10	15	15	25	30	40	50	60	75	75	100	150	150	200	250
Porcentaje de la corriente máxima de operación en	600 ops./h (%)	100	100	100	100	100	100	100	100	100	100	100	100	100	100	100	100	
	1.200 ops./h (%)	100	100	100	100	100	100	100	100	100	75	75	75	75	75	75	75	
	3.000 ops./h (%)	35	35	35	35	35	35	35	35	35	25	25	25	25	25	25	25	
Categoría de servicio AC-4																		
Corriente nominal de operación I_n AC-4 ($U_n \leq 690$ V)	(A)	4	5	6	8	12	14	16	21	27	32	35	48	53	58	88	116	
Potencia nominal de operación	220 / 230 V	(kW)	1,1	1,5	1,5	3	3,7	4,5	5,5	7,5	9,2	11	11	18,5	18,5	22	37	45
		(HP)	1,5	2	2	4	5	6	7,5	10	12,5	15	15	25	25	30	50	60
	380 / 400 V	(kW)	2,2	3	3,7	5,5	7,5	9,2	11	15	18,5	22	25	30	30	37	55	75
		(HP)	3	4	5	7,5	10	12,5	15	20	25	30	33	40	40	50	75	100
	415 V	(kW)	2,2	3,7	4,5	5,5	9,2	11	11	15	18,5	22	25	37	37	45	55	75
		(HP)	3	5	6	7,5	12,5	15	15	20	25	30	33	50	50	60	75	100
	440 V	(kW)	2,2	3,7	4,5	5,5	9,2	11	15	15	22	22	30	37	37	45	55	75
		(HP)	3	5	6	7,5	12,5	15	20	20	30	30	40	50	50	60	75	100
	500 V	(kW)	3	3,7	5,5	7,5	9,2	11	15	18,5	22	22	30	37	45	45	75	90
		(HP)	4	5	7,5	10	12,5	15	20	25	30	30	40	50	60	60	100	125
	660 / 690 V	(kW)	3	4,5	5,5	7,5	11	11	15	18,5	22	30	30	45	45	55	90	90
		(HP)	4	6	7,5	10	15	15	20	25	30	40	40	60	60	75	125	125

Contadores CWM - Características Técnicas

Contactos Principales

Referencia	CWM9	CWM12	CWM18	CWM25	CWM32	CWM40	CWM50	CWM65	CWM80	CWM95	CWM105	CWM112	CWM150	CWM180	CWM300		
Categoría de servicio AC-1																	
	3P (NA) o 4P (4NA)			3P (NA)						3P (NA)							
Corriente térmica convencional I_m ($\theta \leq 55^\circ\text{C}$)	(A)	25	25	32	45	60	60	90	110	110	140	140	180	225	225	410	
Corriente máxima de operación a la temperatura ambiente de (hasta 690 V)	$\theta \leq 55^\circ\text{C}$	(A)	25	25	32	45	60	60	90	110	110	140	140	160	190	200	350
	$\theta \leq 70^\circ\text{C}$	(A)	20	20	25	32	48	48	72	88	88	110	110	120	145	145	250
	$\theta \leq 75^\circ\text{C}$	(A)	17	17	22	26	42	42	63	77	77	95	95	101	124	120	206
Potencia nominal máxima $\theta \leq 55^\circ\text{C}$ (resistores trifásicos)	220 / 230 V	(kW)	9,5	9,5	12	17	22,5	22,5	34	42	42	53	53	68	85	85	156
	380 / 400 V	(kW)	16,5	16,5	21	29,5	39,5	39,5	59	72,5	72,5	92	92	118	145	145	270
	415 / 440 V	(kW)	19	19	24	34	45,5	45,5	68,5	84	84	106,5	106,5	130	160	160	295
	500 V	(kW)	21,5	21,5	27,5	39	52	52	77	95	95	121	121	155	190	190	355
	575 / 600 V	(kW)	24,1	24,1	30,9	43,4	57,9	57,9	86,8	106,1	106,1	135,1	135,1	180	225	225	400
660 / 690 V	(kW)	28,5	28,5	38	51	68,5	68,5	100	125	125	160	160	205	255	255	470	
Sección del cable	(mm ²)	4	4	6	10	16	16	35	35	35	50	50	120	120	120	2 x 150	
Valores de corriente para conexión de	2 polos en paralelo	$I_s \times 1,7$															
	3 polos en paralelo	$I_s \times 2,4$															
	4 polos en paralelo	$I_s \times 3,2$															
Porcentaje de la corriente máxima de operación para	600 ops./h	(%)	100	100	100	100	100	100	100	100	100	100	100	100	100	100	
	1.200 ops./h	(%)	100	100	100	100	100	100	100	100	80	80	80	80	80	80	
	3.000 ops./h	(%)	50	50	50	50	50	50	50	50	50	40	40	40	40	40	
Potencia máxima de operación $\theta \leq 55^\circ\text{C}$ (cargas resistivas)	220 / 230 V	(kW)	5,5	5,5	7,04	9,9	13,2	14,9	22,2	27,5	27,5	34,1	34,1	-	-	-	-
	380 / 400 V	(kW)	9,5	9,5	12,1	17,1	22,8	25,8	38,6	47,5	47,5	58,9	58,9	-	-	-	-
	415 / 440 V	(kW)	10,3	10,3	13,2	18,6	24,9	28,2	42,3	51,8	51,8	64,3	64,3	-	-	-	-
	500 V	(kW)	12,5	12,5	16	22,5	30	34	50,6	62,5	62,5	77,5	77,5	-	-	-	-
	660 / 690 V	(kW)	16,5	16,5	21,1	29,7	39,6	44,8	66	82,5	82,5	102,3	102,3	-	-	-	-

Parametros de Potencia de Acuerdo con la Norma UL

Referencia	CWM9	CWM12	CWM18	CWM25	CWM32	CWM40	CWM50	CWM65	CWM80	CWM95	CWM105	CWM112	CWM150	CWM180	CWM250	CWM300		
Corriente de aplicación general (600 V)	(A)	25	25	32	32	60	60	90	110	110	140	140	170	200	200	300	400	
1-fase	110 / 120 V	(HP)	0,75	0,75	1	2	3	3	5	5	7,5	7,5	10	-	-	-	-	
	220 / 240 V	(HP)	1,5	2	3	5	5	5	7,5	10	15	15	20	-	-	-	-	
3-fases	200 V	(HP)	3	3	5	7,5	10	10	15	20	20	25	30	40	50	60	75	100
	220 / 240 V	(HP)	3	3	5	7,5	10	15	15	20	25	30	40	50	60	75	100	125
	440 / 480 V	(HP)	5	7,5	10	15	20	30	40	50	50	60	75	100	125	150	200	250
	550 / 600 V	(HP)	7,5	10	15	15	25	25	40	50	60	75	75	100	150	200	250	350



Contadores CWM - Características Técnicas

Datos Generales y Circuito de Potencia

Referencia	CWM400	CWM500	CWM630	CWM800
Normas	IEC/EN 60 947, UL 508			
Tensión nominal de aislamiento U_i IEC/EN 60 947 UL	1.000 V 600 V			
Tensión soportada a los impulsos U_{imp}	6 kV			
Frecuencia nominal de operación	25 - 400 Hz			
Grado de protección Circuitos principales Circuitos de control y contactos auxiliares	IP00 IP20			
Temperatura ambiente Temperatura de operación Temperatura de almacenado	-25 °C hasta +55 °C -55 °C hasta +80 °C			
Altitude Valores normales 90% I_g / 80% U_g 80% I_g / 75% U_g	Hasta 3.000 m 3.000 hasta 4.000 m 4.000 hasta 5.000 m			
Categoría de sobretensión / grado de polución	III / 3			
Protección a la intemperie	Acc. to IEC 60680-2			
Numero de polos de los circuitos principales	3			
Tensión nominal de operación U_g	690 V			
Corriente térmica convencional I_{th} (3P / 4P)	450 / 500	580 / 630	660 / 750	900 / 900
I_g /AC-1 (3P / 4P) (A)	450 / 420	580 / 630	660 / 660	900 / 800
Corriente nominal de operación I_g AC-4 ($U_g \leq 440$ V) (A)	300	350	400	630
Categoría de servicio AC-3 Potencia nominal de operación				
220-230 V (kW)	125	150	190	220
400-415 V (kW)	220	265	330	440
440 V (kW)	220	265	330	440
500 V (kW)	225	265	330	500
690 V (kW)	250	300	330	500
Fusible máximo gL-gG (A)	630	800	800	1.000
Numero máximo de maniobras por hora				
AC-1 Op- s/h				
AC-3 Op- s/h	300	300	300	300
AC-4 Op- s/h	1.200	1.200	1.200	1.200
Sin carga Op- s/h	150	150	150	150
	1.200	1.200	1.200	1.200
Vida mecánica Ops x 10 ⁶	5			
Vida eléctrica (AC-3) Ops x 10 ⁶	0,5			0,6

Parametros de Potencia de Acuerdo con la Norma UL

Referencia	CWM400	CWM500	CWM630	CWM800
Corriente de aplicación general (600 V) (A)	450	580	660	900
Trifásico	200 V (HP)	125	200	200
	220 / 240 V (HP)	150	200	300
	440 / 480 V (HP)	300	400	600
	550 / 600 V (HP)	300	400	600



Circuito de Controle

Referencia (contadores 3 y 4 polos)	CWM400	CWM500	CWM630	CWM800
Limites de operación de la bobina	0,85...1,1 x U_g			
Cerrando (xUs)	0,78	0,75		
Apertura (xUs)	0,30...0,60		0,30...0,60	
Consumo	Cerrando (VA)	571	1.000	
	Cerrado (VA)	14	29	
	Disipación (W)	5	7,8	
Numero de terminales	2			

Contadores CWM - Características Técnicas

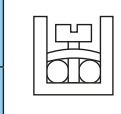
Capacidad de los Terminales e Par de Apriete - Terminales de Potencia

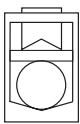
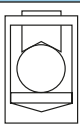
Referencia		CWM9 / CWM12 / CWM18			CWM25		
Tipo de tornillo		M3,5 x 9 Plana / Phillips			M4x 12 Plana / Phillips		
Capacidad de los terminales de potencia ¹⁾		Cable con terminal	Cable sin terminal	Hilo	Cable con terminal	Cable sin terminal	Hilo
mm ²		1x 0,5...4 2x 0,5...2,5	1x 1...6 2x 1...2,5 2x 2,5...6	1x 0,5...6 2x 0,5...2,5 2x 2,5...6	1x 1...6 2x 1...2,5 2x 2,5...4	1x 2,5...10 2x 2,5...10	1x 1...10 2x 1...2,5 2x 2,5...10
AWG (UL)		14...10			14...8		
Par de apriete (N.m)		1...1,5			1,6...2,5		
Par de apriete (lb.in) (UL)		15			16		

Referencia		CWM32 / CWM40			CWM50 / CWM65 / CWM80			CWM95 / CWM105		
Tipo de tornillo		M4x 16,5 Plana / Phillips			M8 Allen 4 mm			M10 Allen 4 mm		
Capacidad de los terminales de potencia		Cable con terminal	Cable sin terminal	Hilo	Cable con terminal	Cable sin terminal	Hilo	Cable con terminal	Cable sin terminal	Hilo
Un conductor abajo										
mm ²		1...16	1,5...16	1...16	2,5...35	6...35	2,5...35	4...35	6...35	4...35
AWG (UL)		14...8			14...1/0			10...1/0		
Un conductor arriba										
mm ²		0,75...16	1...16	0,75...16	1...35	1,5...35	1...35	1,5...50	2,5...50	1,5...50
AWG (UL)		14...8			14...1/0			10...1/0		
Dos conductores - conductor de abajo										
mm ²		1...16	1,5...16	1...16	2,5...25	6...35	2,5...35	4...35	6...35	4...35
AWG (UL)		14...8			14...1/0			10...1/0		
Dos conductores - conductor de arriba										
mm ²		0,75...16	1...16	0,75...16	1...25	1,5...35	1...35	1,5...50	2,5...50	1,5...50
AWG (UL)		14...8			14...1/0			10...1/0		
Par de apriete (N.m)		2...2,5			4...6			5...6,5		
Par de apriete (lb.in) (UL)		22			40			60		

Referencia		CWM112 / CWM150		CWM180		CWM250 / CWM300		CWM400		CWME500 / CWME630		CWME800	
Tipo de tornillo		M6 Cabeza hexagonal		M8 Cabeza hexagonal		M10 Cabeza hexagonal		M12 Cabeza hexagonal		M16 Cabeza hexagonal		M16 Cabeza hexagonal	
Capacidad del terminal principal		Hilo y cable con terminal	Barras	Hilo y cable con terminal	Barras	Hilo y cable con terminal	Barras	Hilo y cable con terminal	Barras	Hilo y cable con terminal	Barras	Hilo y cable con terminal	Barras
mm ²		2x 25...70	2 x (15 x 3)	2x 50...120	2 x (20 x 3)	2x 50...150	2 x (30 x 5)	2x 120...185	2x (30x5)	2x 185...300	2x(50x5)	2x 185...300	2x (60x5)
AWG (UL)		2x 2...3/0	-	2x 1/0...250	-	2x 1/0...300	-	2x 250...400	-	2x 400...600	-	2x 400...600	-
Par de apriete (N.m)		5,4...6		14...16		23...26		23...26		54...60			

Nota: 1) Esta información es válida para los terminales de los contactos auxiliares, incorporados para CWM9 a CWM18.

Contadores CWM - Características Técnicas

Capacidad de los Terminales e Par de Apriete - Terminales de la Bobina

Referencia	CWM9...105			CWM112...300		
Tipo de tornillo	M3,5 x 10 Plana / Phillips			M3,5 x 10 Plana / Phillips		
Terminales de la bobina	Cable con terminal	Cable sin terminal	Hilo	Cable con terminal	Cable sin terminal	Hilo
mm ²	1x 0,5...4 2x 0,5...1,5 2x 1...2,5	1x 1...4 2x 1...2,5	1x 0,5...4 2x 0,5...1,5 2x 1...2,5	1x 0,5...4 2x 0,5...1,5 2x 1...2,5	1x 1...4 2x 1...2,5	1x 0,5...4 2x 0,5...1,5 2x 1...2,5
AWG (UL)	1x 20...10 2x 20...14 2x 16...12	1x 16...10 2x 16...12	1x 20...10 2x 20...14 2x 16...12	1x 20...10 2x 20...14 2x 16...12	1x 16...10 2x 16...12	1x 20...10 2x 20...14 2x 16...12
Par de apriete (N.m)	0,8...1,1			0,8...1,1		
Par de apriete (lb.in) (UL)	10			10		

Referencia	CWM400...CWM800		
Tipo de tornillo	M4 Plana / Phillips		
Terminales de la bobina	Cable con terminal	Cable sin terminal	Hilo
mm ²	1x 1,25...5,5 or 2x 1,25...5,5		
AWG (UL)	16...10		
Par de apriete (N.m)	2...2,3		
Par de apriete (lb.in) (UL)	17,7...20,3		

Capacidad de los Terminales e Par de Apriete - Bloques de Contactos Auxiliares

Referencia	BCXMF BCXML		
Tipo de tornillo	M3,5 x 9 Fenda / Philips		
Bloque de contacto auxiliar	Cable con terminal	Cable sin terminal	Hilo
mm ²	1x 0,5...4 2x 0,5...2,5	1x 0,75...2,5 2x 0,75...2,5	1x 0,5...4 2x 0,5...2,5
AWG (UL)	22...12		
Par de apriete (N.m)	0,8...1,1		
Par de apriete (lb.in) (UL)	10		

Contadores CWM - Características Técnicas

Contactos Auxiliares

Referencia		CWM9	CWM12	CWM18	BCXMF..	BCXML...
Tensión nominal de aislamiento U_i IEC/EN 60 947 UL	(V) (V)		1.000 600			1.000 600
Tensión nominal de operación U_e	(V)		690			690
Corriente térmica convencional I_{th}	(A)		16			10
Corriente nominal de operación I_e AC-15	220 - 240 V (A) 380 - 400 V (A) 415 V (A) 500 V (A)		10 6 5 4		6 4 3,5 2,5	4 3 - 2
UL			A600		A600	-
DC-13	24 V (A) 48 V (A) 110 V (A) 220 V (A)		6 4 2 0,7		6 4 2 0,7	4 2 0,55 0,3
UL			P600		Q600	-
Capacidad de conexión I_m AC-15/AC-11 AC-13/DC-11	$U_e \leq 400$ V 50/60 Hz (A) $U_e \leq 220$ V cc (A)		250 250		90 90	90 -
Capacidad de desconexión I_c AC-15/AC-11 AC-13/DC-11	$U_e \leq 400$ V 50/60 Hz (A) $U_e \leq 220$ V cc (A)		250 2		60 0,95	60 -
Fusible máximo gL/gG	(A)		10			10
Confiabilidad del circuito de control			$I_e \text{ min} = 5 \text{ mA}$. $U_e \text{ min} = 17 \text{ V}$			$I_e \text{ min} = 1 \text{ mA}$ $U_e \text{ min} = 17 \text{ V}$
Vida eléctrica	Ops		10^6			
Vida mecánica	Ops		15×10^6			10×10^6

Referencia		BCXML11 CWM800 / BCXMRL11 CWM800	
Corriente térmica convencional I_{th}	(A)	16	
Corriente nominal de operación I_e Categoría de servicio (A600)	110 V (A) 220 V (A) 440 V (A) 600 V (A)	AC-15 6 5 3 3	AC-12 10 10 5 5
Categoría de servicio (P600)	24 V (A) 48 V (A) 110 V (A) 220 V (A)	DC-13 6 3 1,2 0,2	DC-12 5 3 1,3 0,25
Vida mecánica	Ops x 10^6	10	
Vida eléctrica Operaciones x 10^6	AC-15	0,5	
	AC-12	0,25	
	DC-13 / DC-12	0,5	
Numero máximo de maniobras por hora		1.800	

Contadores CWM - Características Técnicas

Contadores para Circuitos de Iluminación

Tipo de lámpara	W	A	μF	Número máximo de lámparas por fase 220 V										
				CWM9	CWM12	CWM18	CWM25	CWM32	CWM40	CWM50	CWM65	CWM80	CWM95	CWM105
Incandescente	60	0,27	-	62	62	70	77	85	122	156	191	222	264	284
	100	0,45	-	40	40	50	60	66	73	95	116	133	160	170
	200	0,91	-	20	20	25	30	33	36	47	58	66	79	84
	300	1,36	-	13	13	17	20	22	24	31	38	44	53	56
	500	2,27	-	8	8	10	12	12	14	19	23	26	31	33
	1.000	4,50	-	4	4	5	6	6	7	9	11	13	16	16
	2.000	9,1	-	1	1	2	3	3	3	4	5	6	8	8
	AC-5b ¹⁾ (A)			18	18	23	27	30	33	43	52	60	73	77
Fluorescente sin compensación	15	0,23	-	88	98	126	155	224	237	355	390	434	496	553
	20	0,37	-	57	61	78	110	139	147	221	243	270	309	344
	40	0,44	-	48	51	66	93	118	124	186	204	227	260	289
	65	0,7	-	30	32	41	58	74	78	116	127	142	163	181
	100	1,5	-	14	16	19	27	34	36	54	59	66	76	85
Fluorescente con compensación	15	0,23	3,5	61	77	94	111	134	149	191	232	273	312	347
	20	0,25	4,5	48	61	74	87	103	115	148	180	212	243	270
	40	0,3	4,5	48	61	74	87	103	115	148	180	212	243	270
	65	0,45	7	31	39	47	56	66	74	95	115	136	155	173
	100	0,7	18	11	14	17	21	23	29	37	45	53	60	67
Lámparas de mercurio de alta presión sin compensación	250	2,13	-	6	8	10	12	15	18	27	30	33	36	42
	400	3,25	-	4	5	6	8	10	12	18	20	22	24	28
	700	5,4	-	2	3	4	5	6	7	11	12	13	14	17
	1.000	7,5	-	2	2	3	3	4	5	8	9	9	10	12
Lámparas de mercurio de alta presión con compensación	250	1,3	20	11	14	18	22	27	33	49	55	60	66	77
	400	2,1	25	7	9	11	14	17	20	31	34	37	41	48
	700	3,6	40	4	5	6	8	10	12	18	20	22	24	28
	1.000	5,3	60	3	3	4	5	7	8	12	13	15	16	19
Lámpara de sodio de alta presión sin compensación	250	3	-	4	5	7	9	11	13	19	21	24	26	30
	400	4,4	-	3	4	5	6	7	9	13	15	16	18	20
	1.000	10,3	-	1	2	2	2	3	4	6	6	7	7	9
Lámpara de sodio de alta presión con compensación	250	1,45	40	10	12	16	20	25	30	44	49	54	59	69
	400	2,5	45	6	7	9	11	14	17	26	29	31	34	40
	1.000	5,5	100	3	3	4	5	6	8	12	13	14	16	18
Yoduro metálico sin compensación	250	2,17	-	4	5	7	9	12	12	19	21	23	25	29
	400	3,48	-	3	3	4	6	8	8	12	13	14	16	18
	700	6,09	-	1	2	2	3	4	4	7	7	8	9	10
	1.000	8,7	-	1	1	2	2	3	3	5	5	6	6	7
	2.000	17,39	-	1	1	1	1	2	2	2	3	3	3	4
Yoduro metálico con compensación	250	1,4	32	7	9	11	16	21	21	32	36	39	43	50
	400	2	45	5	6	8	11	15	15	23	25	28	30	35
	700	3,6	65	3	3	4	6	8	8	13	14	15	17	19
	1.000	5,3	85	2	2	3	4	6	6	8	9	10	11	13
	2.000	10,6	100	1	1	2	2	3	3	4	5	5	6	7

Nota: 1) Valores indicativos - Es altamente recomendado considerar los valores de corriente de cierre y nominales AC-1 cuando seleccionar el contador para categoría de servicio AC-5b (AC-5b - Maniobra de lámparas incandescentes).

Contactores CWM - Características Técnicas

Contactores para Circuitos de Iluminación

Tipo de lámpara	W	A	μF	Número máximo de lámparas por fase 220 V				
				CWM112	CWM150	CWM180	CWM250	CWM300
Incandescente	60	0,27	-	318	404	467	578	667
	100	0,45	-	193	245	283	350	404
	200	0,91	-	95	121	140	173	200
	300	1,36	-	64	81	93	116	133
	500	2,27	-	38	49	56	69	80
	1.000	4,50	-	19	24	28	35	40
	2.000	9,1	-	10	12	14	17	20
	AC-5b ¹⁾ (A)			87	110	127	158	182
Fluorescente sin compensación	15	0,23	-	652	815	978	1.522	1.783
	20	0,37	-	405	507	608	946	1.108
	40	0,44	-	341	426	511	795	932
	65	0,7	-	214	268	321	500	586
	100	1,5	-	100	125	150	233	273
Fluorescente con compensación	15	0,23	3,5	409	520	600	743	857
	20	0,25	4,5	318	404	467	578	667
	40	0,3	4,5	318	404	467	578	667
	65	0,45	7	204	260	300	371	429
	100	0,7	18	79	101	117	144	167
Lámparas de mercurio de alta presión sin compensación	250	2,13	-	54	62	68	106	124
	400	3,25	-	36	40	45	69	81
	700	5,4	-	21	24	27	42	49
	1.000	7,5	-	15	18	19	30	35
Lámparas de mercurio de alta presión con compensación	250	1,3	20	79	100	116	143	165
	400	2,1	25	63	80	92	114	132
	700	3,6	40	39	50	58	72	83
	1.000	5,30	60	26	33	39	48	55
Lámpara de sodio de alta presión sin compensación	250	3,0	-	39	44	48	75	88
	400	4,4	-	26	30	33	51	60
	1.000	10,3	-	11	13	14	22	26
Lámpara de sodio de alta presión con compensación	250	1,45	40	45	57	66	81	94
	400	2,5	45	40	51	58	72	83
	1.000	5,5	100	18	23	26	33	38
Yoduro metálico sin compensación	250	2,17	-	37	42	47	73	85
	400	3,48	-	23	26	29	45	53
	700	6,09	-	13	15	17	26	30
	1.000	8,7	-	9	11	12	18	21
	2.000	17,39	-	5	5	6	9	11
Yoduro metálico con compensación	250	1,4	32	56	71	82	102	117
	400	2	45	40	51	58	72	83
	700	3,6	65	28	35	40	50	58
	1.000	5,3	85	21	27	31	38	44
	2.000	10,6	100	18	23	26	33	38

Nota: 1) Valores indicativos - Es altamente recomendado considerar los valores de corriente de cierre y nominales AC-1 cuando seleccionar el contactor para categoría de servicio AC-5b (AC-5b - Maniobra de lámparas incandescentes).

Contadores CWM - Características Técnicas

CC - Categoría de Servicio para Contactores

Categoría de Servicio DC-1 (L/R ≤1ms)

Referencia		CWM9	CWM12	CWM18	CWM25	CWM32	CWM40	CWM50	CWM65	CWM80	CWM95	CWM105
U _e	Polos en serie	Corriente máxima de operación I _e (A)										
≤24 V	1	18	18	18	25	32	40	50	65	65	80	80
	2	25	25	32	45	60	60	90	110	110	140	140
	3	25	25	32	45	60	60	90	110	110	140	140
	4	25	25	32	-							
≤48 V	1	15	15	15	20	25	35	45	55	55	70	70
	2	25	25	32	45	60	60	90	110	110	140	140
	3	25	25	32	45	60	60	90	110	110	140	140
	4	25	25	32	-							
≤60 V	1	12	12	12	18	18	32	40	50	50	65	65
	2	25	25	32	45	60	60	90	110	110	140	140
	3	25	25	32	45	60	60	90	110	110	140	140
	4	25	25	32	-							
≤125 V	1	6	6	6	8	8	8	16	16	16	16	16
	2	18	18	18	25	45	45	80	90	90	110	110
	3	25	25	25	32	60	60	90	110	110	140	140
	4	25	25	32	-							
≤220 V	1	0,8	0,8	0,8	0,8	1	1	2	2	2	2	2
	2	7,5	7,5	7,5	8	8	8	20	20	20	20	20
	3	25	25	25	32	50	50	90	110	110	140	140
	4	25	25	32	-							
≤440 V	1	0,4	0,4	0,4	0,4	0,5	0,5	0,8	0,8	0,8	0,8	0,8
	2	0,8	0,8	0,8	0,8	1	1	2	2	2	2	2
	3	8	8	8	10	10	10	15	15	15	15	15
	4	15	15	15	-							
≤600 V	1	-	-	-	-	-	-	-	-	-	-	-
	2	0,4	0,4	0,4	0,4	0,5	0,5	1	1	1	1	1
	3	4	4	4	5	5	5	7,5	7,5	7,5	7,5	7,5
	4	8	8	10	-							

Categoría de Servicio DC-3 (L/R ≤2.5ms)

Referencia		CWM9	CWM12	CWM18	CWM25	CWM32	CWM40	CWM50	CWM65	CWM80	CWM95	CWM105
U _e	Polos en serie	Corriente máxima de operación I _e (A)										
≤24 V	1	12	12	12	18	25	32	40	50	50	65	65
	2	18	18	18	25	40	40	65	80	80	105	105
	3	18	18	18	25	40	40	65	80	80	105	105
	4	18	18	18	-							
≤48 V	1	9	9	9	12	18	20	30	35	35	45	45
	2	18	18	18	25	40	40	65	80	80	105	105
	3	18	18	18	25	40	40	65	80	80	105	105
	4	18	18	18	-							
≤60 V	1	7,5	7,5	7,5	10	15	15	25	30	30	35	35
	2	18	18	18	25	40	40	65	80	80	105	105
	3	18	18	18	25	40	40	65	80	80	105	105
	4	18	18	18	-							
≤125 V	1	2	2	2	2	3	3	3	3	3	3	3
	2	10	10	12	18	25	32	50	60	60	85	85
	3	15	15	18	25	32	40	65	80	80	105	105
	4	15	15	18	-							
≤220 V	1	0,6	0,6	0,6	0,6	0,6	0,6	0,8	0,8	0,8	0,8	0,8
	2	2	2	2	2	2	2	7	7	7	7	7
	3	12	12	12	18	25	32	50	65	65	95	95
	4	12	15	18	-							
≤440 V	1	-	-	-	-	-	-	-	-	-	-	-
	2	0,3	0,3	0,3	0,3	0,5	0,5	1	1	1	1	1
	3	1,5	1,5	1,5	1,5	3	3	3	3	3	3	3
	4	1,5	6	6	-							
≤600 V	1	-	-	-	-	-	-	-	-	-	-	-
	2	-	-	-	-	-	-	-	-	-	-	-
	3	0,8	0,8	0,8	0,8	1,5	1,5	1,5	1,5	1,5	1,5	1,5
	4	1	2,5	2,5	-							

Contadores CWM - Características Técnicas

CC - Categoría de Servicio para Contactores

Categoría de Servicio DC-5 (L/R ≤15ms)

Referencia	CWM9	CWM12	CWM18	CWM25	CWM32	CWM40	CWM50	CWM65	CWM80	CWM95	CWM105	
U _e	Polos en serie	Corriente máxima de operación I _e (A)										
≤24 V	1	12	12	12	18	25	32	40	50	50	65	65
	2	18	18	18	25	40	40	65	80	80	105	105
	3	18	18	18	25	40	40	65	80	80	105	105
	4	18	18	18	-							
≤48 V	1	9	9	9	12	18	20	30	35	35	45	45
	2	18	18	18	25	40	40	65	80	80	105	105
	3	18	18	18	25	40	40	65	80	80	105	105
	4	18	18	18	-							
≤60 V	1	7,5	7,5	7,5	10	15	15	25	30	30	35	35
	2	18	18	18	25	40	40	65	80	80	105	105
	3	18	18	18	25	40	40	65	80	80	105	105
	4	18	18	18	-							
≤125 V	1	0,8	0,8	0,8	0,8	1,2	1,2	1,2	1,2	1,2	1,2	1,2
	2	5	5	5	5	5	5	50	60	60	80	80
	3	15	15	15	20	25	32	60	70	70	95	95
	4	15	15	18	-							
≤220 V	1	-	-	-	-	-	-	0,5	0,5	0,5	0,5	0,5
	2	0,8	0,8	0,8	0,8	0,8	0,8	3	3	3	4	4
	3	3	3	3	3	3	3	7	7	7	7	7
	4	10	10	10	-							
≤440 V	1	-	-	-	-	-	-	-	-	-	-	-
	2	-	-	-	-	-	-	-	-	-	-	-
	3	0,4	0,5	0,5	0,5	0,7	0,7	1	1	1	1	1
	4	1,5	2	2	-							
≤600 V	1	-	-	-	-	-	-	-	-	-	-	-
	2	-	-	-	-	-	-	-	-	-	-	-
	3	-	-	-	-	-	-	-	-	-	-	-
	4	0,5	0,75	0,75	-							

Categoría de Servicio DC-1 (L/R ≤1ms)

Referencia	CWM112	CWM150	CWM180	CWM250	CWM300	
U _e	Polos en serie	Corriente máxima de operación I _e (A)				
≤24 V	1	160	160	200	300	300
	2	180	225	225	350	410
	3	180	225	225	350	410
≤110 V	1	18	18	18	33	33
	2	112	150	170	250	280
	3	180	225	225	350	410
≤220 V	1	-	-	-	-	-
	2	90	120	140	200	220
	3	180	225	225	350	410
≤440 V	1	-	-	-	-	-
	2	-	-	-	-	-
	3	85	105	105	165	195



Contadores CWM - Características Técnicas

CC - Categoría de Servicio para Contactores

Categoría de Servicio DC-3 / DC-5 (L/R ≤15ms)

Referencia		CWM112	CWM150	CWM180	CWM250	CWM300
U _e	Polos en serie	Corriente máxima de operación I _e (A)				
≤24 V	1	112	112	180	250	250
	2	112	150	180	250	300
	3	112	150	180	250	300
≤110 V	1	18	18	18	33	33
	2	80	95	105	185	205
	3	112	150	180	250	300
≤220 V	1	-	-	-	-	-
	2	55	55	65	70	80
	3	80	120	150	200	200
≤440 V	1	-	-	-	-	-
	2	-	-	-	-	-
	3	27	40	50	67	67

Categoría de Servicio DC-1 (L/R ≤1ms)

Referencia		CWM400	CWM500	CWM630	CWM800
U _e	Polos en serie	Corriente máxima de operación I _e (A)			
≤24 V	2	400	580	630	800
	3	400	580	630	800
≤48 V	2	240	580	630	800
	3	400	580	630	800
≤110 V	2	200	520	630	630
	3	400	580	630	800
≤220 V	2	200	450	630	630
	3	300	580	630	800

Categoría de Servicio DC-2 / DC-4 (L/R ≤15ms)

Referencia		CWM400	CWM500	CWM630	CWM800
U _e	Polos en serie	Corriente máxima de operación I _e (A)			
≤24 V	2	400	580	630	800
	3	400	580	630	800
≤48 V	2	200	580	630	630
	3	280	580	630	630
≤110 V	2	150	500	630	630
	3	200	550	630	630
≤220 V	2	90	480	630	630
	3	150	500	630	630

1 Polo en Serie



3 Polos en Serie

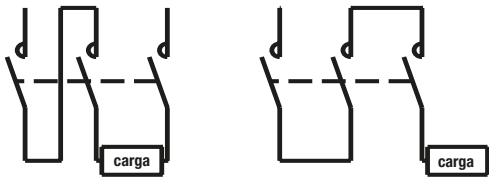

2 Polos en Serie

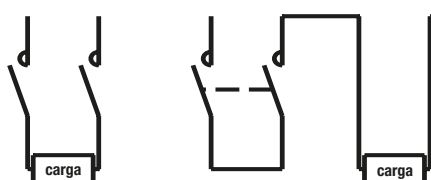

4 Polos en Serie

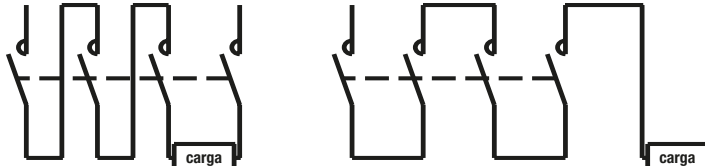

Contadores CWM - Características Técnicas

Marcación de los Terminales EN 50012

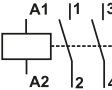
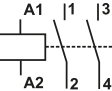
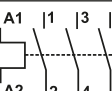
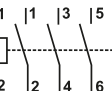
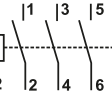
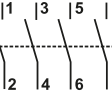
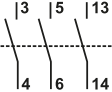
Diagrama	Numero distintivo y versión de combinación	NA	NC	Referencia	Bloques de contactos adicionales
Sin bloque de contacto auxiliar					
	10E	1	0	CWM9-10 CWM12-10 CWM18-10	-
	01E	0	1	CWM9-01 CWM12-01 CWM18-01	-
Bloques de contactos auxiliares de montaje frontal BCXMF10 o BCXMF01					
	11E	1	1	CWM9-10 CWM12-10 CWM18-10	+ BCXMF01
	21E	2	1	CWM9-10 CWM12-10 CWM18-10	+ BCXMF10 + BCXMF01
	12E	1	2	CWM9-10 CWM12-10 CWM18-10	+ 2 BCXMF01
	31E	3	1	CWM9-10 CWM12-10 CWM18-10	+ 2 BCXMF10 + BCXMF01
	41E	4	1	CWM9-10 CWM12-10 CWM18-10	+ 3 BCXMF10 + BCXMF01













Contadores CWM - Características Técnicas

Marcación de los Terminales EN 50012

Diagrama	Numero distintivo y versión de combinación	NA	NC	Referencia	Bloques de contactos adicionales
Bloques de contactos auxiliares de montaje frontal BCXMF10 o BCXMF01					
	22E	2	2	CWM9-10 CWM12-10 CWM18-10	+ 2 BCXMF01 + BCXMF10
	32E	3	2	CWM9-10 CWM12-10 CWM18-10	+ 2 BCXMF01 + 2 BCXMF10
	13E	1	3	CWM9-10 CWM12-10 CWM18-10	+ 3 BCXMF01
	23E	2	3	CWM9-10 CWM12-10 CWM18-10	+ 3 BCXMF01 + BCXMF10
Bloques de contactos auxiliares laterales con 2 contactos por bloque					
	11E	1	1	CWM25-00 hasta CWM105-00	+ BCXML11
	31E	3	1	CWM25-00 hasta CWM105-00	+ BCXML11 + BCXML20
	22E	2	2	CWM25-00 hasta CWM105-00	+ 1 BCXML11 + 1 BCXMR11
Sin bloque de contacto auxiliar					
	-	0	0	CWM25-00 hasta CWM105-00	-
Bloques de contactos auxiliares de montaje frontal BCXMF10 o BCXMF01					
	10E	1	0	CWM25-00 hasta CWM105-00	+ BCXMF10
	01E	0	1	CWM25-00 hasta CWM105-00	+ BCXMF01





Contadores CWM - Características Técnicas

Marcación de los Terminales EN 50012

Diagrama	Numero distintivo y versión de combinación	NA	NC	Referencia	Bloques de contactos adicionales
Bloques de contactos auxiliares de montaje frontal BCXMF10 o BCXMF01					
	11E	1	1	CWM25-00 hasta CWM105-00	+ BCXMF10 + BCXMF01
	21E	2	1	CWM25-00 hasta CWM105-00	+ 2 BCXMF10 + BCXMF01
	12E	1	2	CWM25-00 hasta CWM105-00	+ BCXMF10 + 2 BCXMF01
	31E	3	1	CWM25-00 hasta CWM105-00	+ 3 BCXMF10 + BCXMF01
	41E	4	1	CWM50-00 hasta CWM105-00	+ 4 BCXMF10 + BCXMF01
	22E	2	2	CWM25-00 hasta CWM105-00	+ 2 BCXMF01 + 2 BCXMF10
	32E	3	2	CWM50-00 hasta CWM105-00	+ 2 BCXMF01 + 3 BCXMF10
	13E	1	3	CWM25-00 hasta CWM105-00	+ BCXMF10 + 3 BCXMF01
	23E	2	3	CWM50-00 hasta CWM105-00	+ 3 BCXMF01 + 2 BCXMF10
Contadores sin bloques de contactos auxiliares + bloques de contactos auxiliares laterales con 2 contactos por bloque					
	22	2	2	CWM112 hasta CWME800	+ 2 BCXML11
	44	4	4	CWM112 hasta CWME800	+ 2 BCXML11 + 2 BCXML11

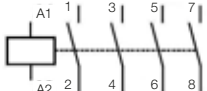
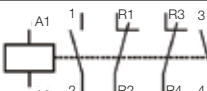
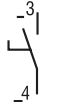
Contadores CWM - Características Técnicas

Marcación de los Terminales EN 50012

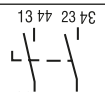
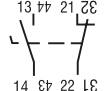
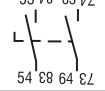
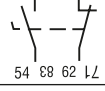
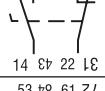
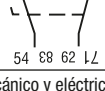
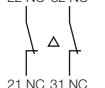
Diagrama	Configuración	Contactos de potencia		Referencia
		NA	NC	
Contadores 4 polos				
	-	4	0	CWM9-00-40 ♦ CWM12-00-40 ♦ CWM18-00-40 ♦
	-	2	2	CWM9-00-22 ♦ CWM12-00-22 ♦ CWM18-00-22 ♦
Diagrama	Configuración	Contactos auxiliares		Referencia
		NA	NC	
Bloques de contactos auxiliares de montaje frontal BCXMF10 o BCXMF01				
	10	1	0	BCXMF10
	01	0	1	BCXMF01
	10	1	0	BCXMF10
	01	0	1	BCXMF01
Diagrama	Configuración	Contactos auxiliares		Referencia
		NA	NC	
Bloques de contactos auxiliares laterales con 2 contactos por bloque				
	20	2	0	BCXML20
	11	1	1	BCXML11
	20	2	0	BCXMR20
	11	1	1	BCXMR11
	11	1	1	BCXML11 CWME800
	11	1	1	BCXMR11 CWME800
Enclavamiento mecánico y eléctrico para contadores				
	02	0	2	BLIM.02

Contactores CWM - Características Técnicas

Curvas de Vida Eléctrica

Categoría AC-3 ($U_e \leq 440$ V ca)

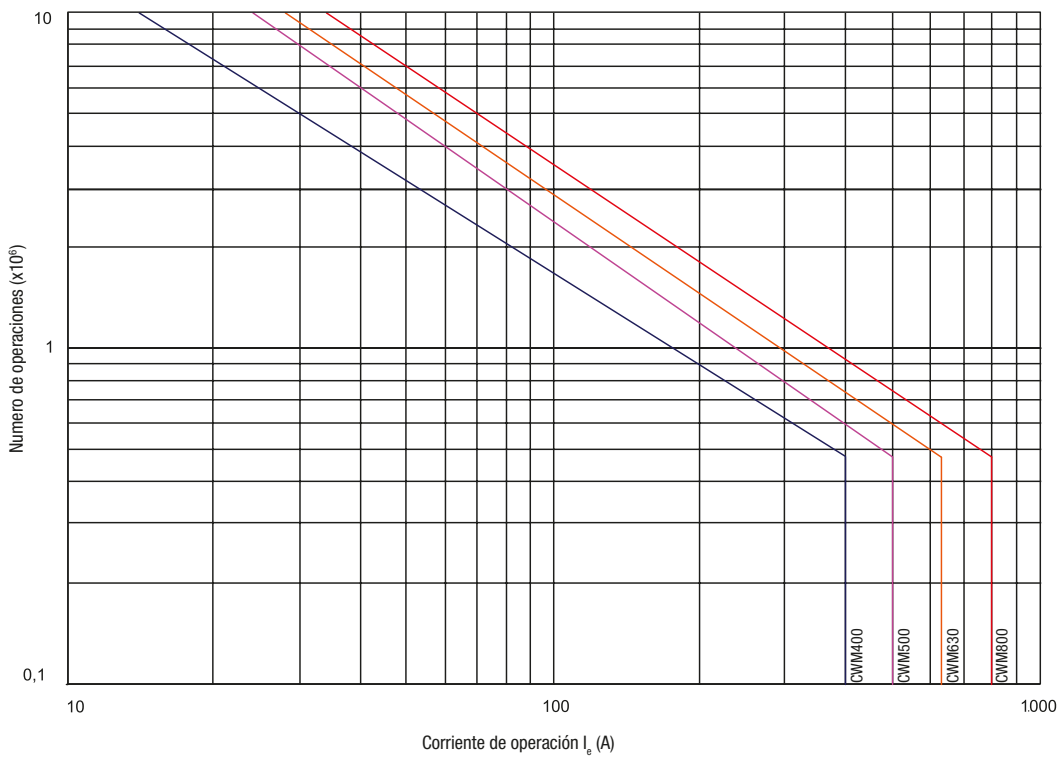
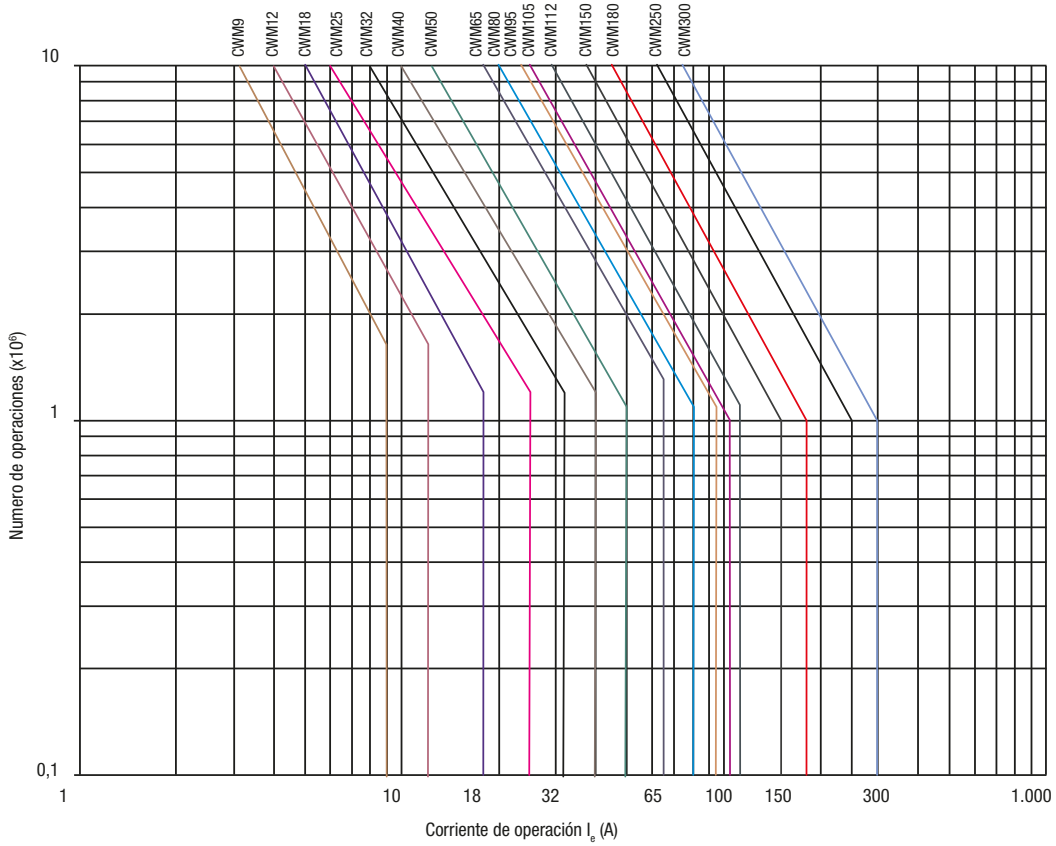

Contactores CWM - Características Técnicas

Curvas de Vida Eléctrica

Categoría AC-4 ($U_e \leq 440$ V ca)

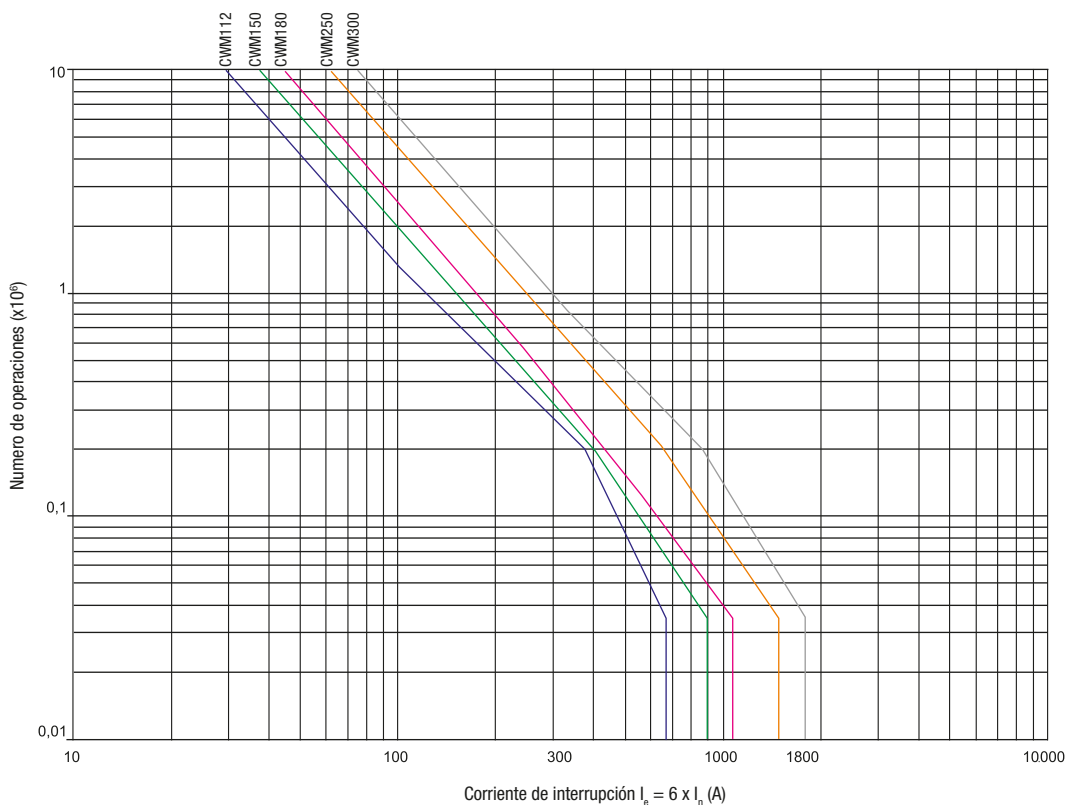
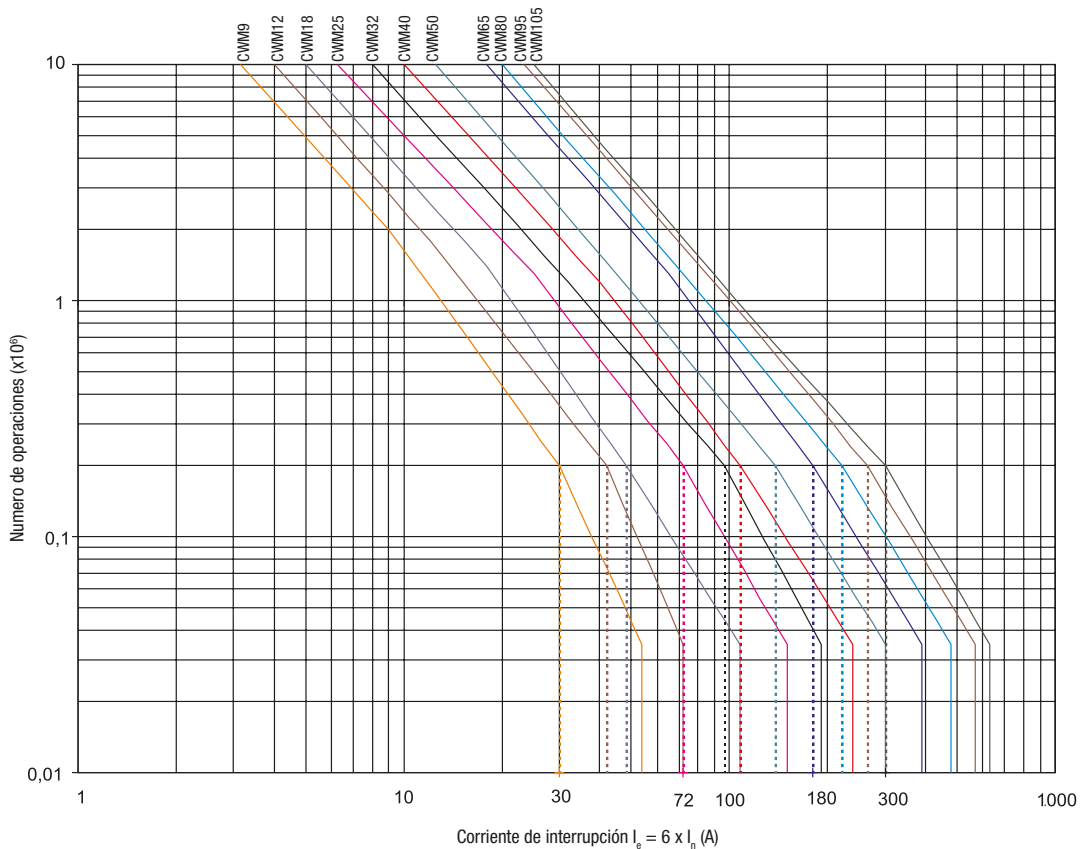

Contactores CWM - Características Técnicas

Curvas de Vida Eléctrica

Categoría AC-4 ($U_e \leq 440$ V ca)

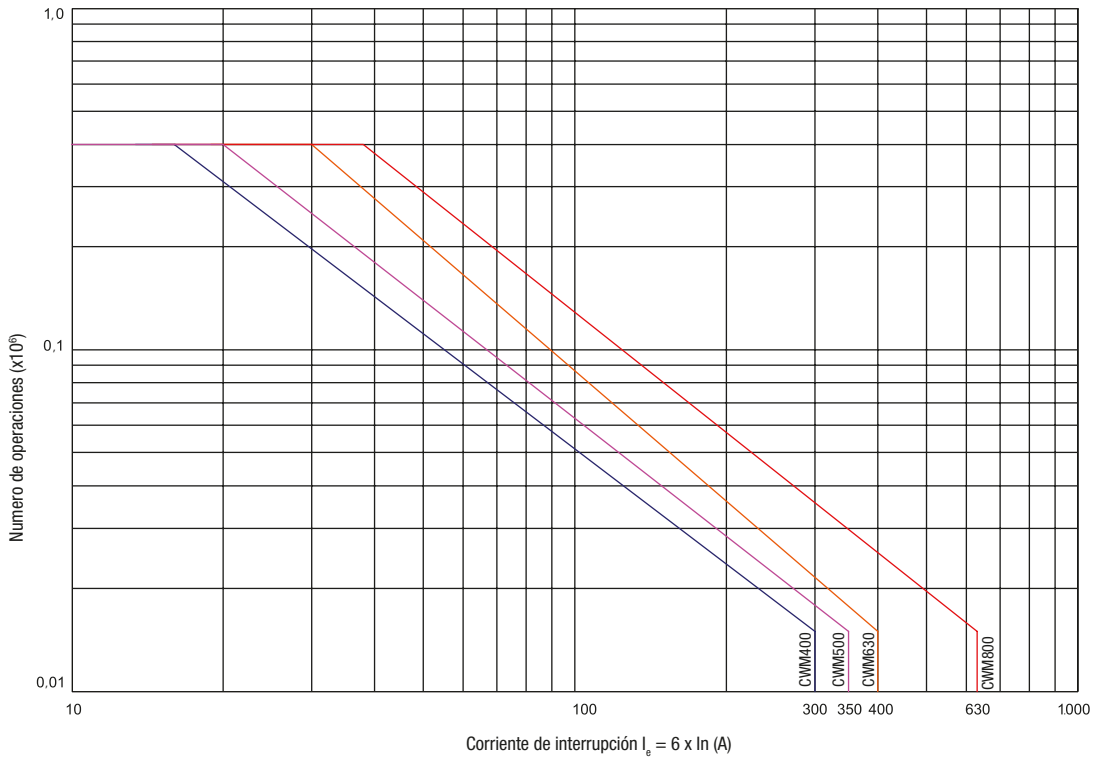

Categoría AC-1 ($U_e \leq 690$ V ca)

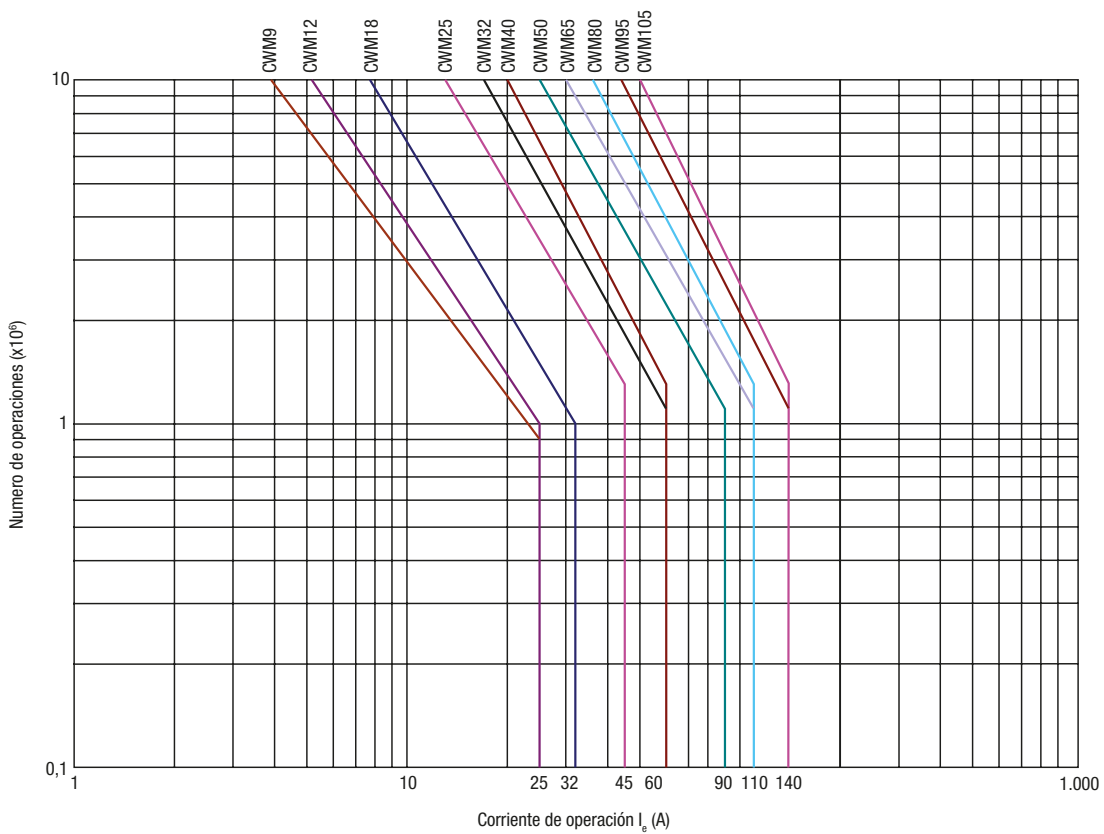

Contactores CWM - Características Técnicas

Curvas de Vida Eléctrica

Categoría AC-1 ($U_e \leq 690$ V ca)

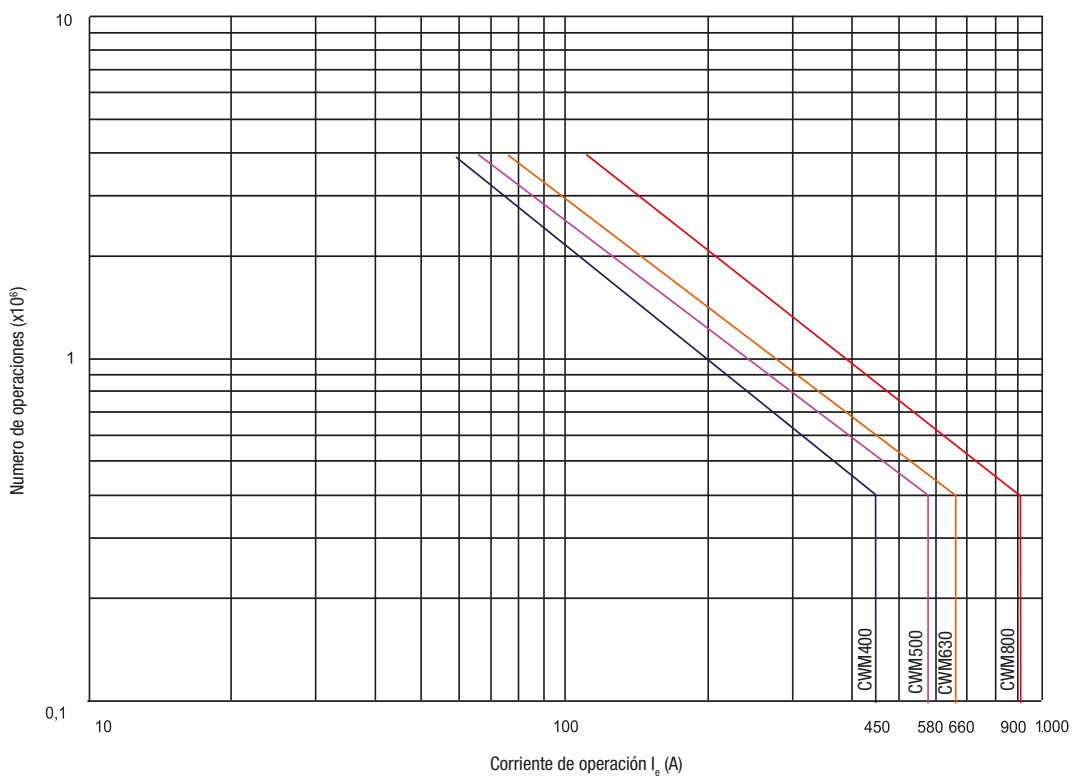
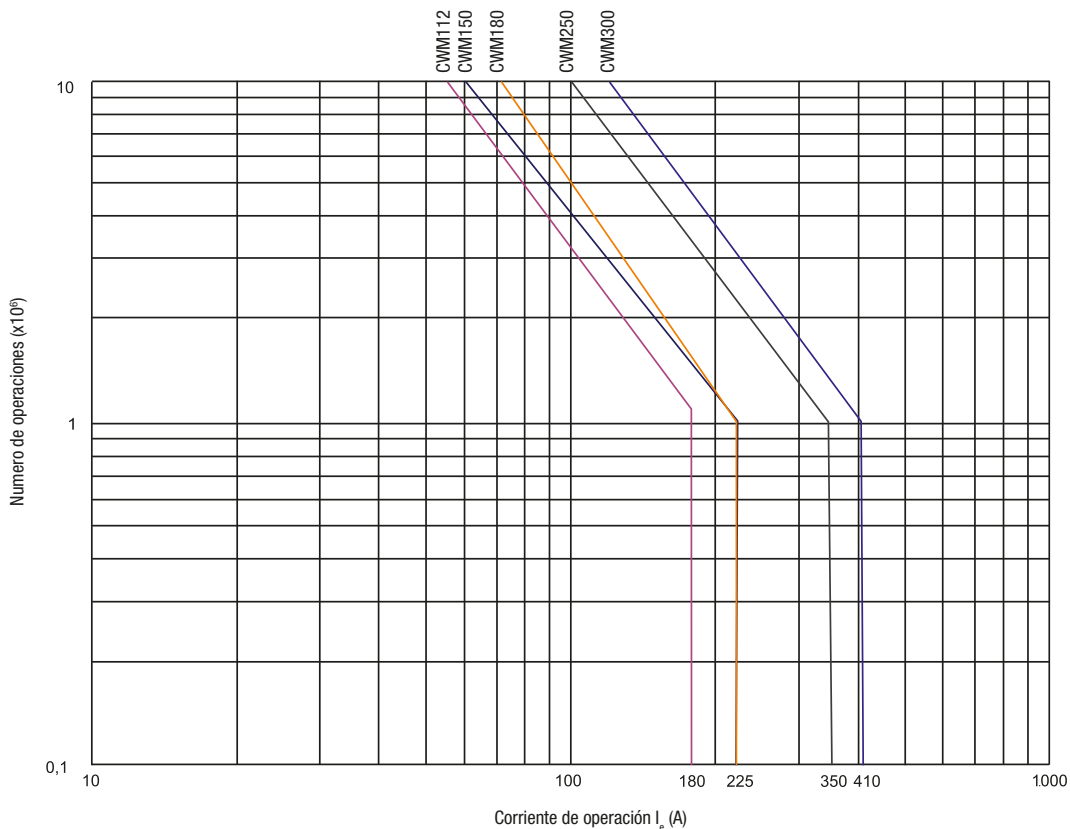

Contadores CWM - Dimensiones (mm)

CWM9, CWM12 y CWM18

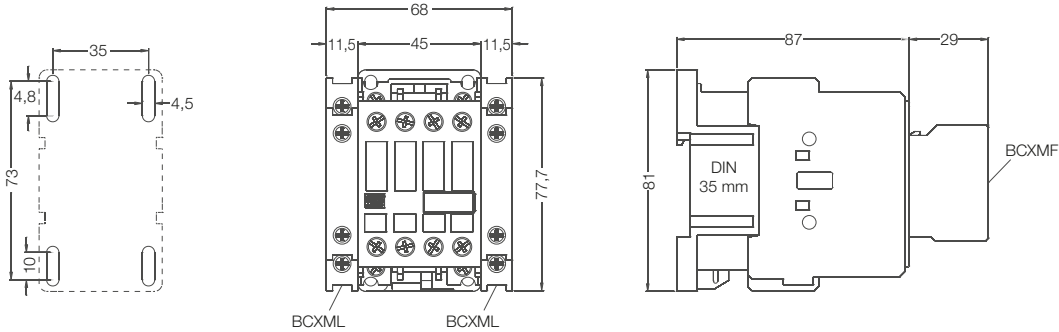

CWM25

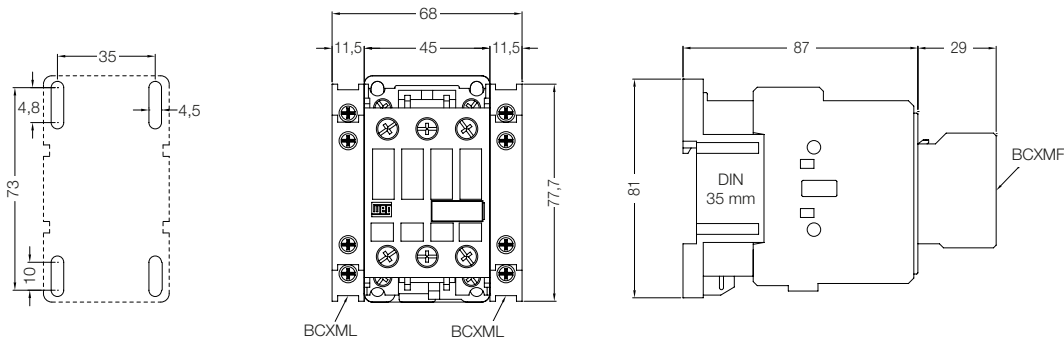

CWM32 y CWM40

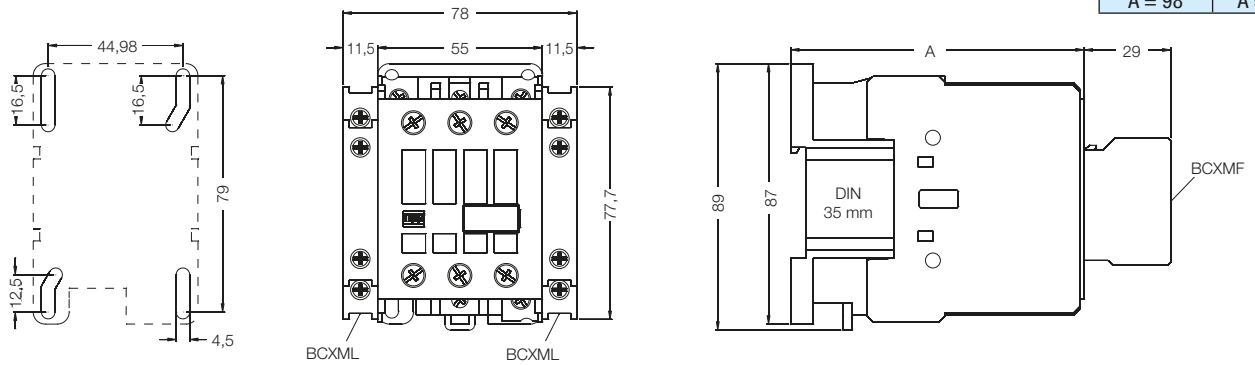

CWM50, CWM65 y CWM80

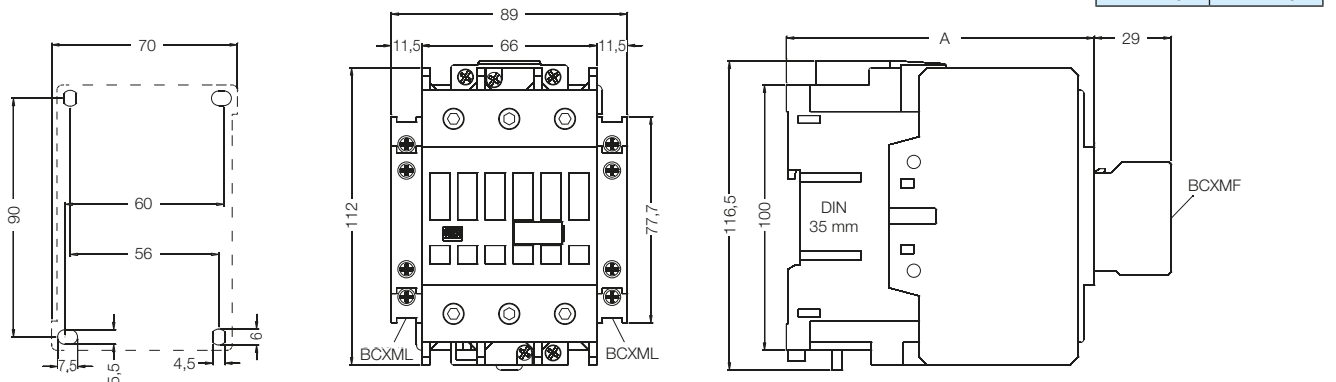

Contadores CWM - Dimensiones (mm)

CWM95 y CWM105

Bobina	
CA	CC
A = 126	A = 126

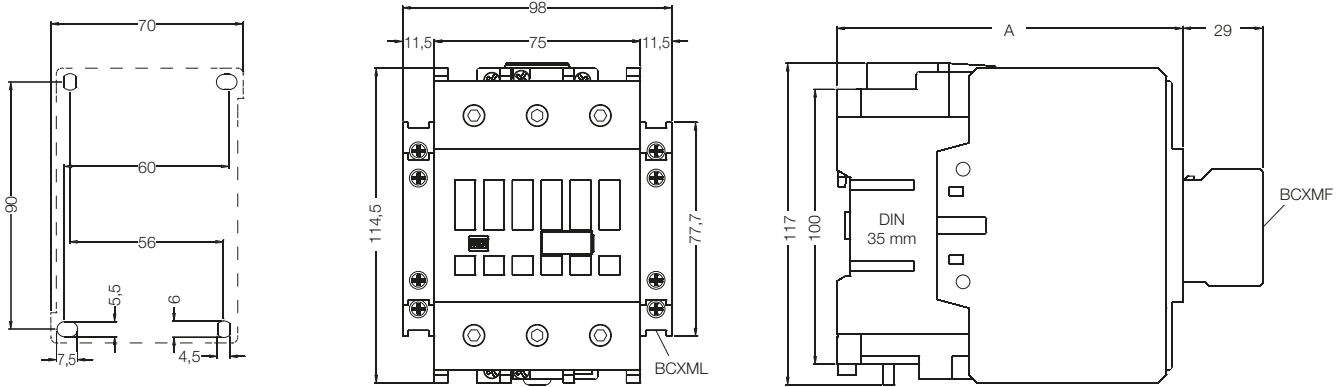

CWM112 y CWM150

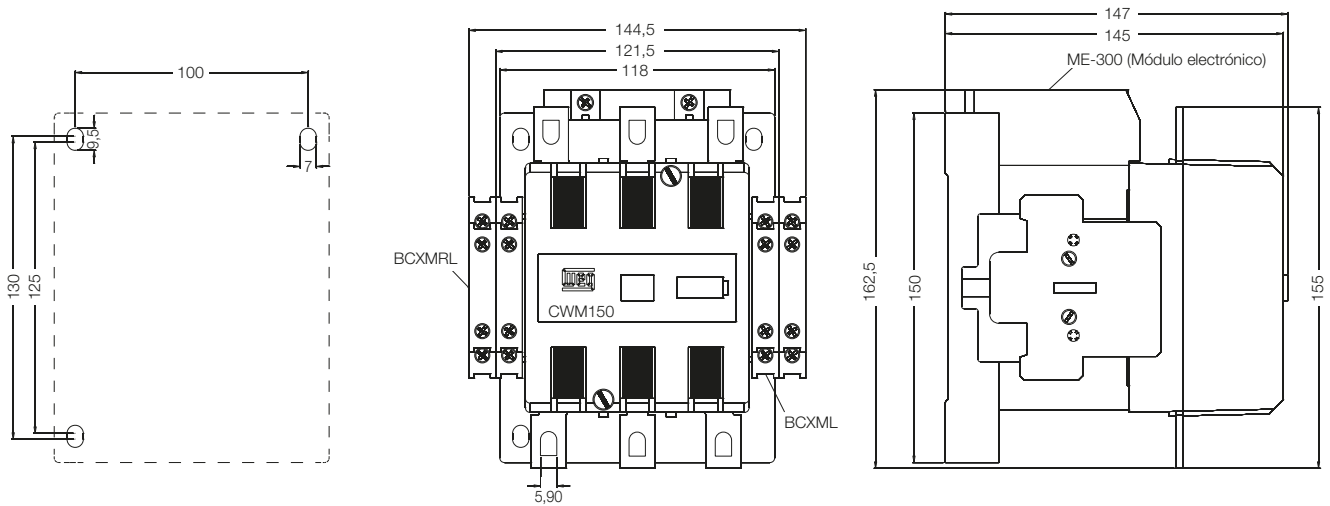

CWM180

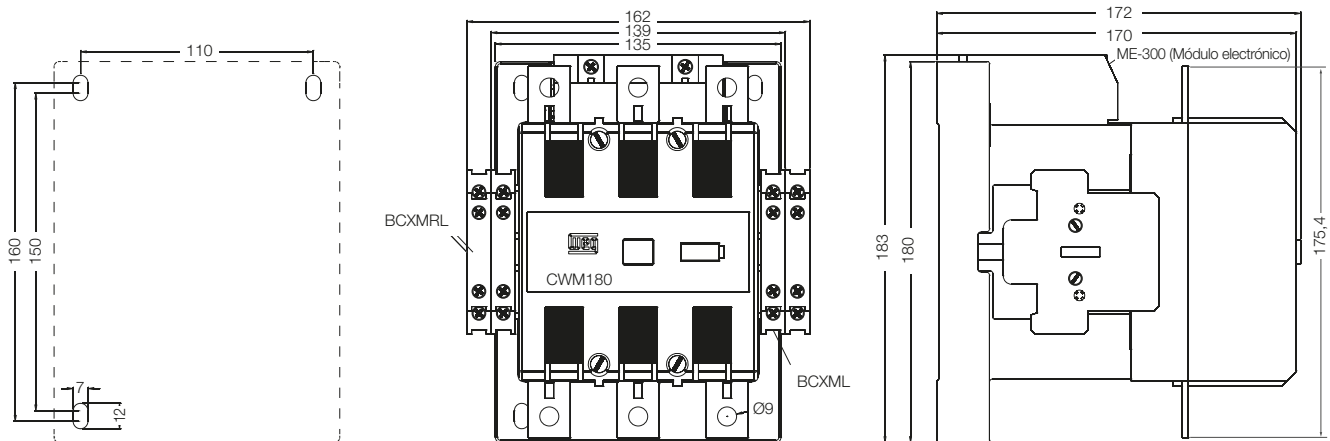

Contadores CWM - Dimensiones (mm)

CWM250 y CWM300

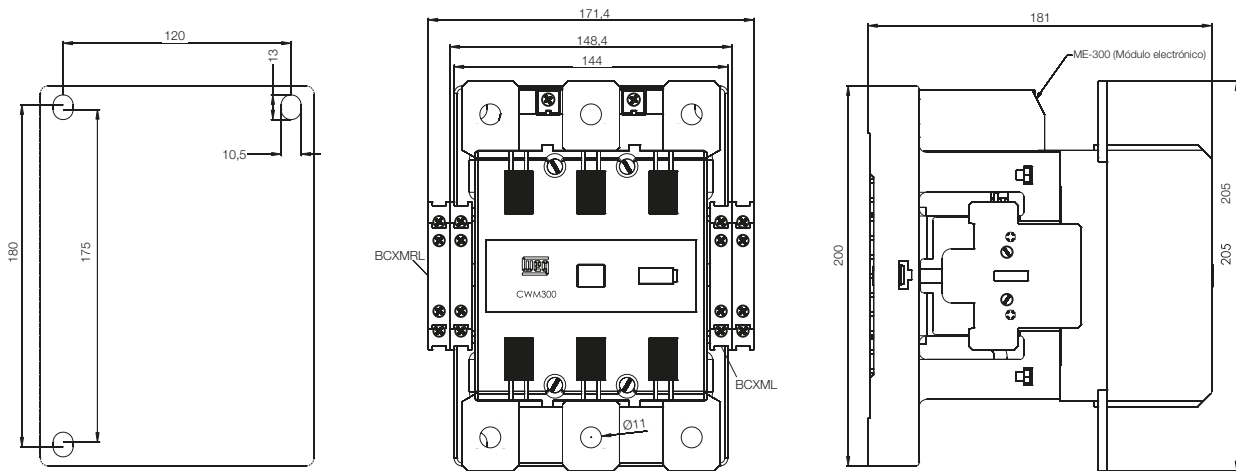

BLIM9-105 y BLIM.02

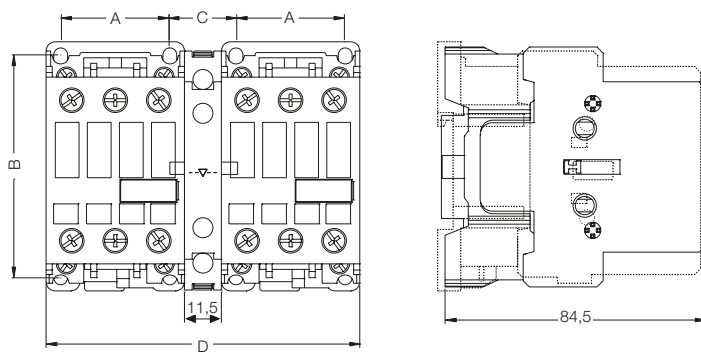

Referencia	A	B	C	D
CWM9...25	35	72,5	22	102
CWM32/40	45	79	22	122
CWM50...80	57	90	21	144
CWM95/105	57	90	29,8	153

BLIM112-300

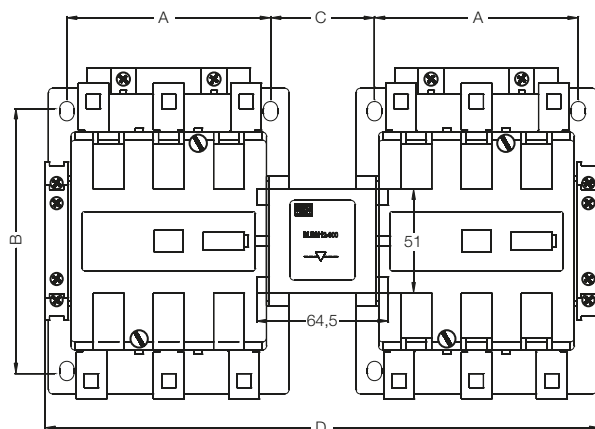

Referencia	A	B	C	D
CWM112/150	100	130	51	272,5
CWM180	110	160	58,5	303,5
CWM250/300	120	180	57	325,4

Contadores CWM - Dimensiones (mm)

BMP CWM112...300

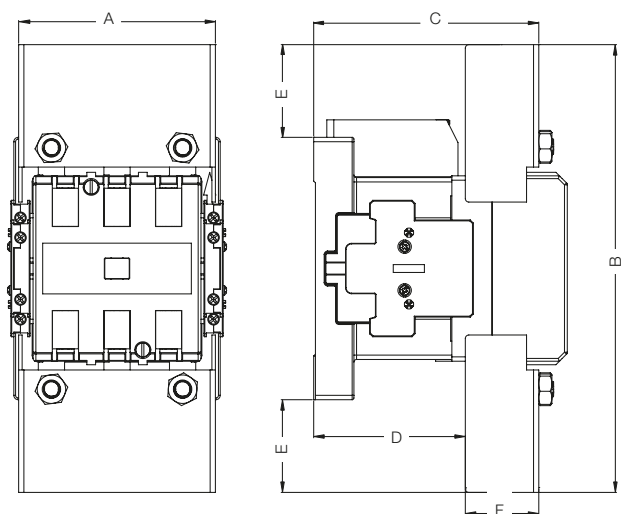

	BMP CWM150 + CWM112/150	BMP CWM180 + CWM180	BMP CWM300 + CWM250/300
A	112,5	127,5	148,5
B	256	290,4	320,8
C	128	137,7	146
D	86	90,7	84
E	53	55,2	60,5
F	42	47	62

TB... + CWM112...300

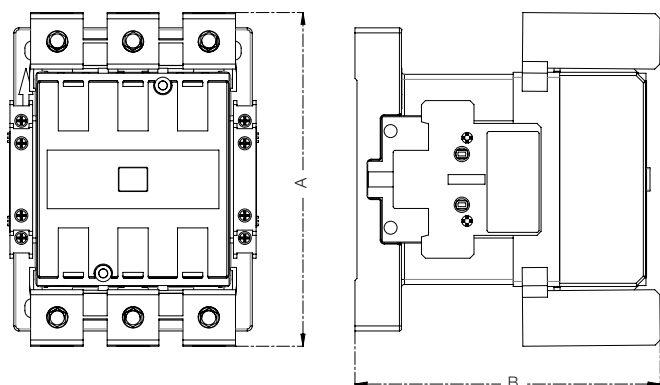

	TB150 + CWM112/150	TB180 + CWM180	TB300 + CWM250/300
A	167,6	190,3	218,6
B	151,1	176	193,8

Posición de Montaje

CWM9...105

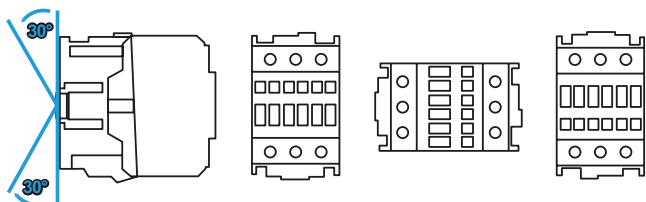

CWM112...300

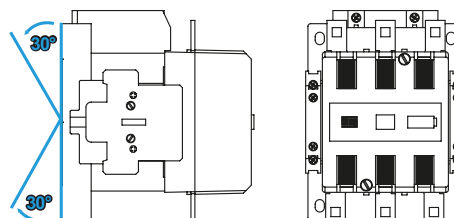

Contactores CWM - Dimensiones (mm)

CWM400 - 3 Polos

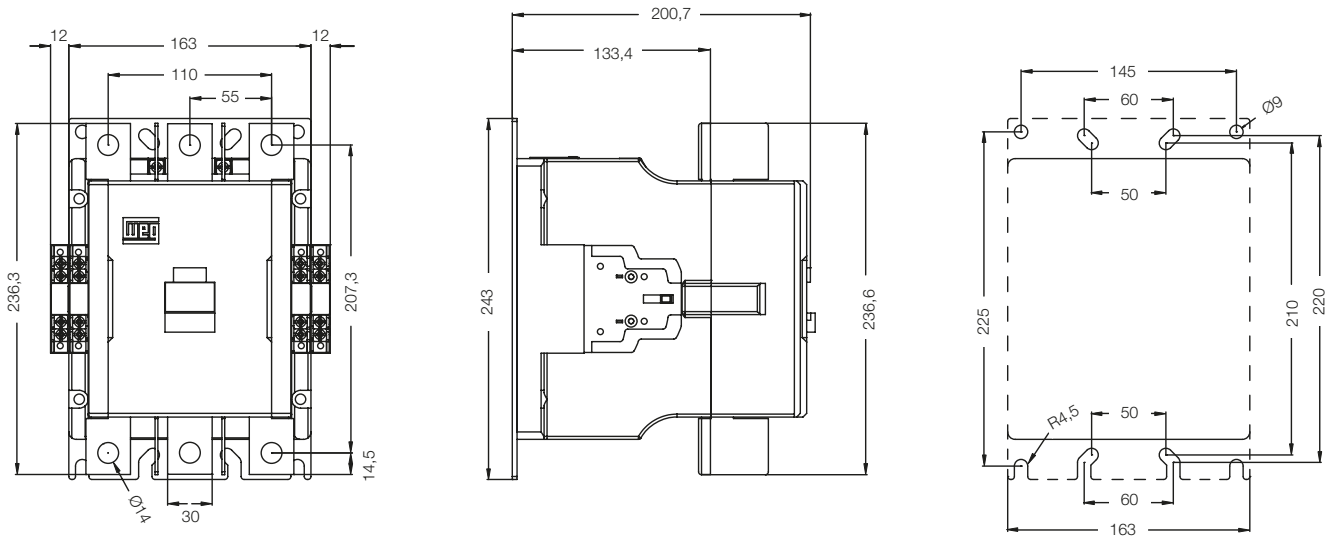

CWM400 - 4 Polos

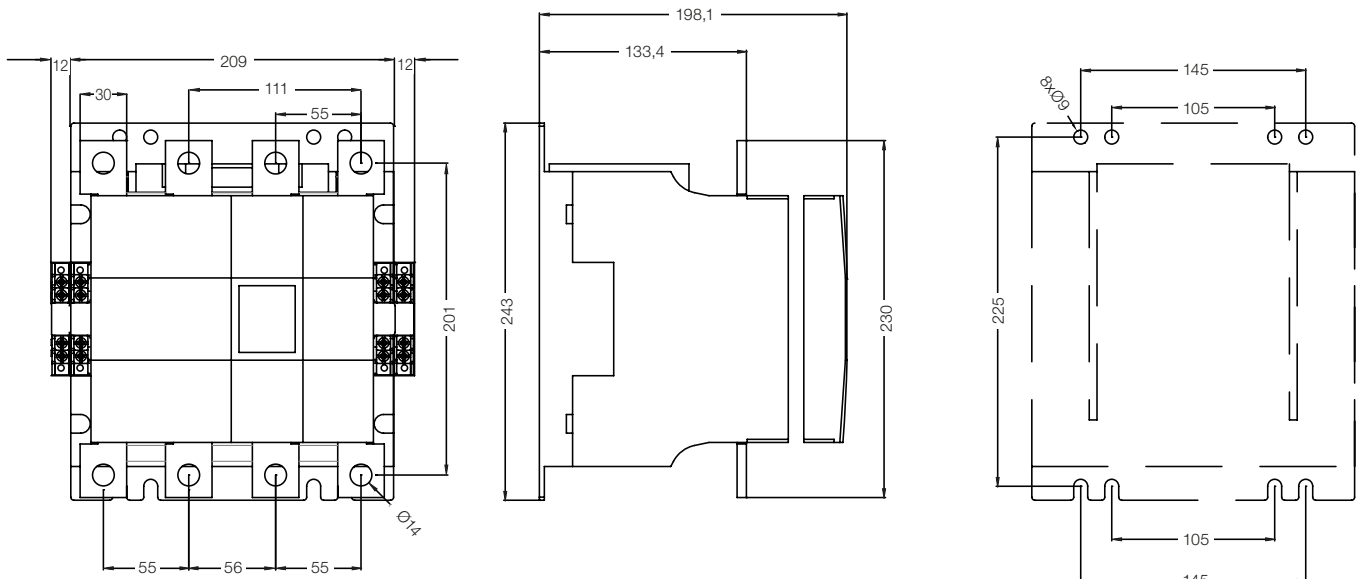

Contadores CWM - Dimensiones (mm)

CWM500, CWM630 y CWM800 - 3 Polos

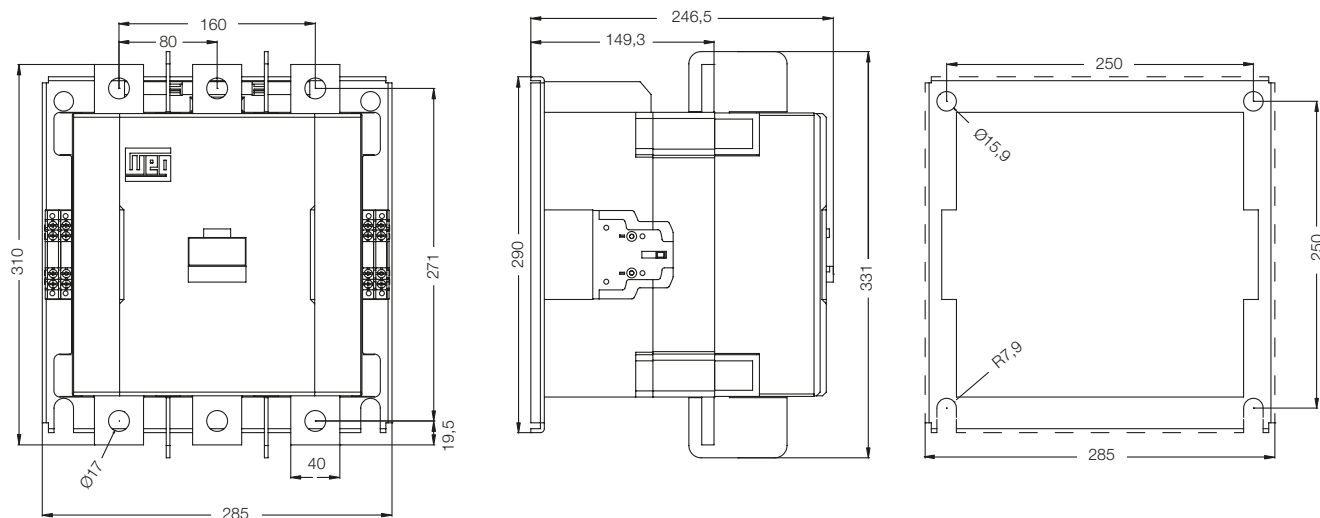

CWM500, CWM630 y CWM800 - 4 Polos

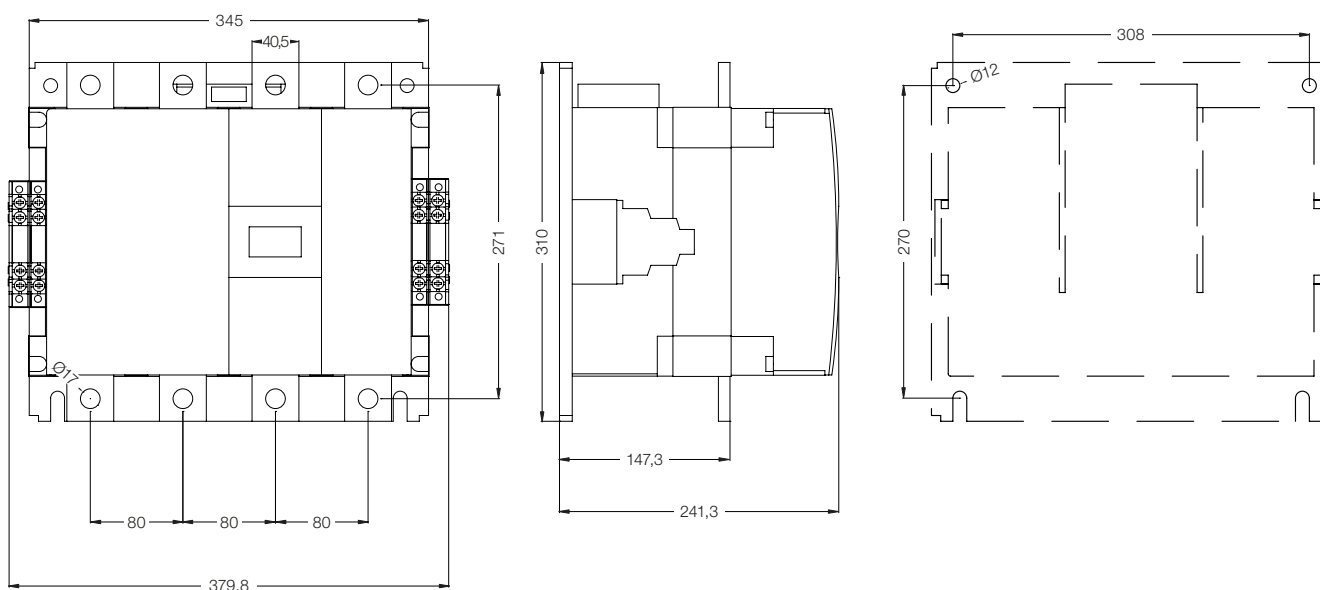

Contadores CWM - Dimensiones (mm)

BLIM CWM400

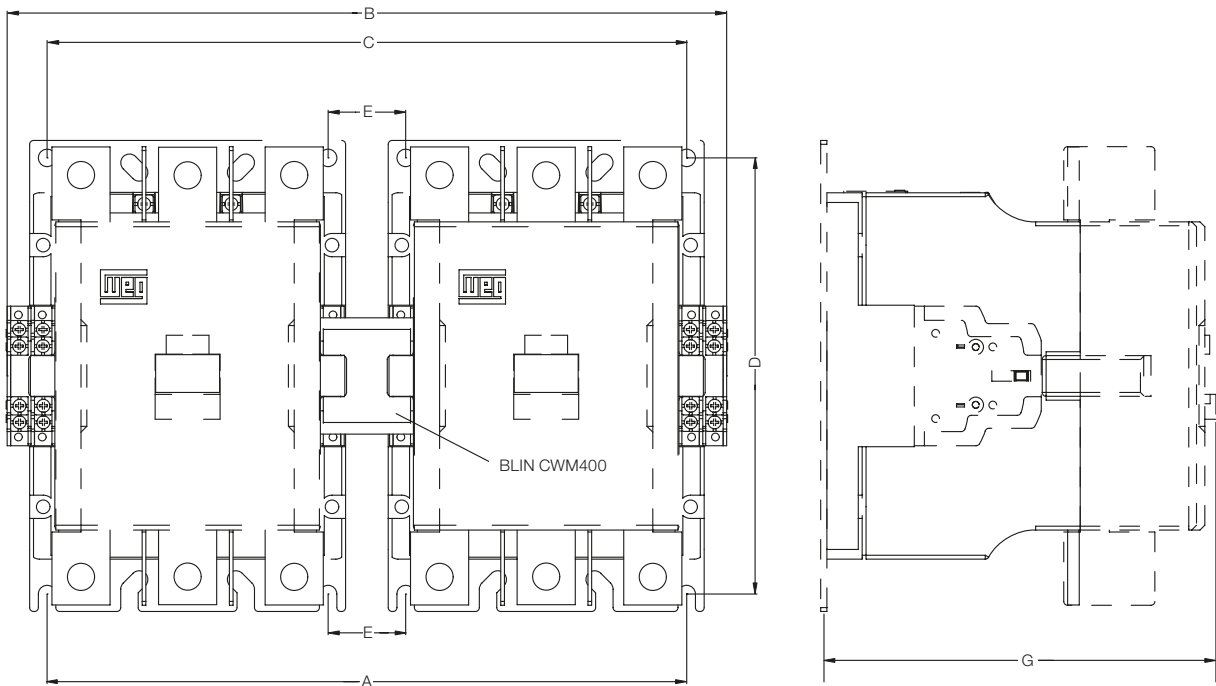

BLIM CWM800

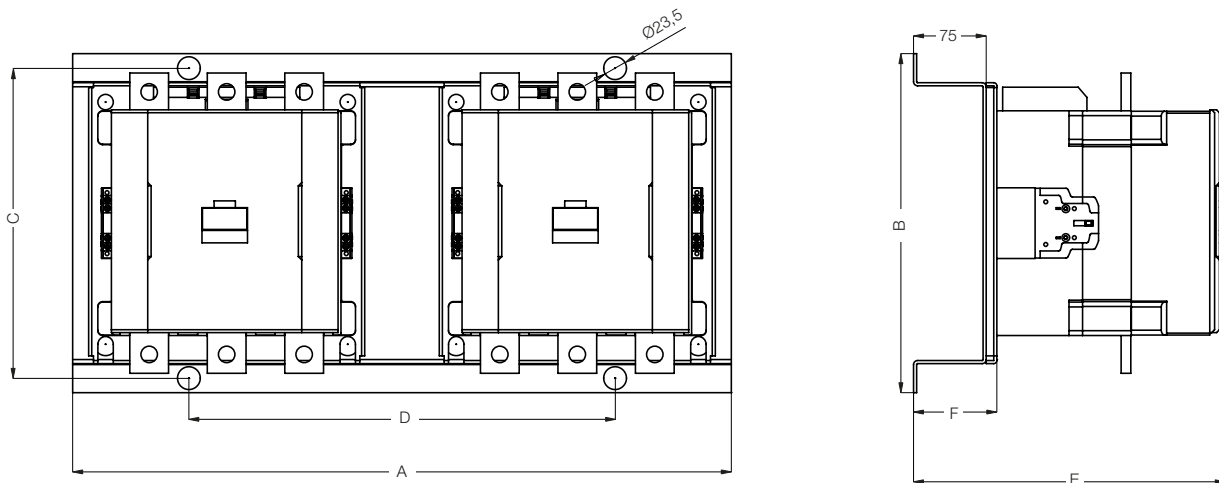

	BLIM CWM400 + CWM400	
	3 polos	4 polos
A	330	375
B	371,2	464
C	330	375
D	225	225
E	40	85
F	40	85
G	203,9	198,2

	BLIM CWM800 + CWM500...800	
	3 polos	4 polos
A	680	740
B	351	370
C	321	340
D	440	440
E	321	316,3
F	86	86
G	75	75

Contadores CWM - Dimensiones (mm)

BMP CWM400...800

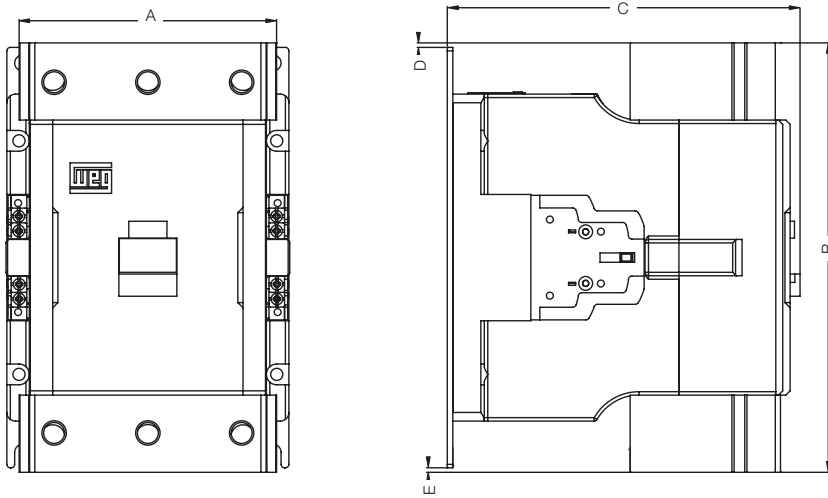

	BMP CWM400 + CWM400		BMP CWM800 + CWM500...800	
	3 polos	4 polos	3 polos	4 polos
A	148,8	214	234	314
B	248,2	250,8	320,2	350,5
C	200,7	198,2	246,5	241,3
D	2,6	1,76	111,6	20,25
E	2,6	7,76	15,1	20,25

BMJ CWM400...800

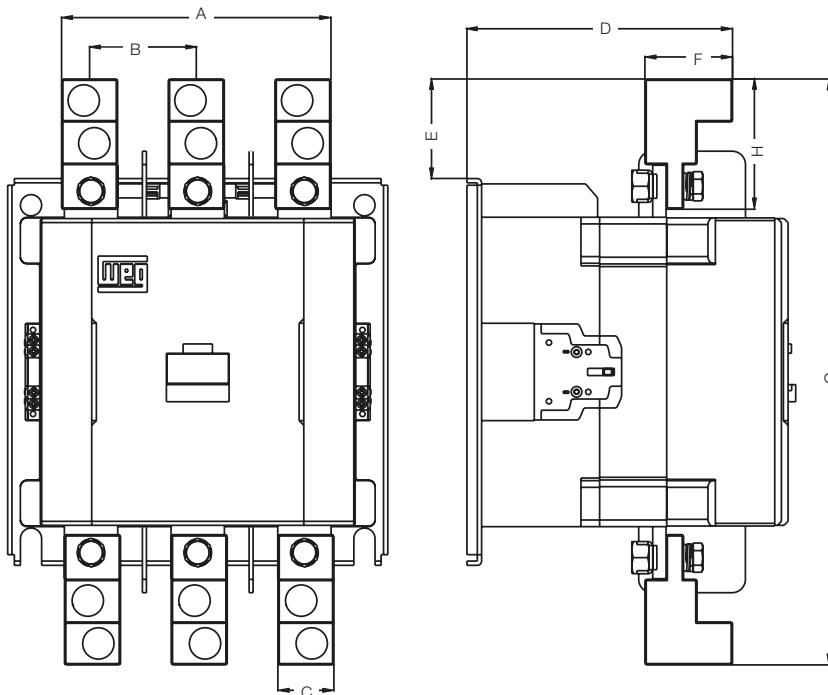

	BMJ CWM400 + CWM400	BMJ CWM800 + CWM500...800
A	140,2	202
B	55	80
C	30,2	42
D	187,4	199,15
E	53,6	74,65
F	59,5	65,7
G	350,2	439,3

Posición de Montaje

CWM400...800

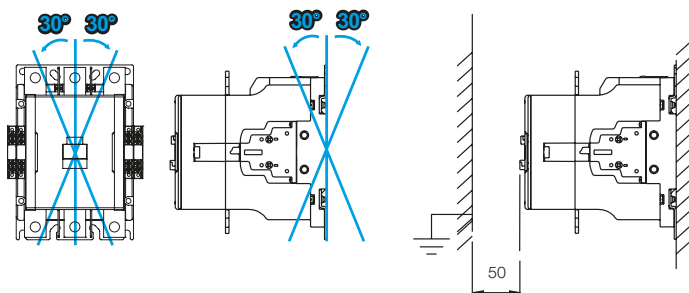



La presencia global es esencial. Entender lo que usted precisa también.

Presencia Global

Con más de 30.000 colaboradores en todo el mundo, somos uno de los mayores productores mundiales de motores eléctricos, equipos y sistemas electro-electrónicos. Estamos constantemente expandiendo nuestro portafolio de productos y servicios con conocimiento especializado y de mercado. Creamos soluciones integradas y personalizadas que van desde productos innovadores hasta asistencia postventa completa.

Con el *know-how* de WEG, los **Contactores - Línea CWM** son la elección adecuada para su aplicación y su negocio, con seguridad, eficiencia y confiabilidad.

 **Disponibilidad** es contar con una red global de servicios

 **Alianza** es crear soluciones que satisfagan sus necesidades

 **Competitividad** es unir tecnología e innovación

Conozca

Productos de alto desempeño y confiabilidad para mejorar su proceso productivo.

Excelencia es desarrollar soluciones que aumentan la productividad de nuestros clientes, con una línea completa para automatización industrial.



Acceda a: www.weg.net

 youtube.com/wegvideos

Sucursales WEG en el Mundo

ALEMANIA

Türnich - Kerpen
Teléfono: +49 2237 92910
info-de@weg.net

Balingen - Baden-Württemberg
Teléfono: +49 7433 90410
info@weg-antriebe.de

ARGENTINA

San Francisco - Córdoba
Teléfono: +54 3564 421484
info-ar@weg.net

Córdoba - Córdoba
Teléfono: +54 351 4641366
weg-morbe@weg.com.ar

Buenos Aires
Teléfono: +54 11 42998000
ventas@pulverlux.com.ar

AUSTRALIA

Scoresby - Victoria
Teléfono: +61 3 97654600
info-au@weg.net

AUSTRIA

Markt Piesting - Wiener
Neustadt-Land
Teléfono: +43 2633 4040
watt@wattdrive.com

BÉLGICA

Nivelles - Bélgica
Teléfono: +32 67 888420
info-be@weg.net

BRASIL

Jaraguá do Sul - Santa Catarina
Teléfono: +55 47 32764000
info-br@weg.net

CHILE

La Reina - Santiago
Teléfono: +56 2 27848900
info-cl@weg.net

CHINA

Nantong - Jiangsu
Teléfono: +86 513 85989333
info-cn@weg.net

Changzhou - Jiangsu
Teléfono: +86 519 88067692
info-cn@weg.net

COLOMBIA

San Cayetano - Bogotá
Teléfono: +57 1 4160166
info-co@weg.net

ECUADOR

El Batán - Quito
Teléfono: +593 2 5144339
ceccato@weg.net

EMIRATOS ARABES UNIDOS

Jebel Ali - Dubai
Teléfono: +971 4 8130800
info-ae@weg.net

ESPAÑA

Coslada - Madrid
Teléfono: +34 91 6553008
wegiberia@wegiberia.es

EEUU

Duluth - Georgia
Teléfono: +1 678 2492000
info-us@weg.net

Minneapolis - Minnesota
Teléfono: +1 612 3788000

FRANCIA

Saint-Quentin-Fallavier - Isère
Teléfono: +33 4 74991135
info-fr@weg.net

GHANA

Accra
Teléfono: +233 30 2766490
info@zestghana.com.gh

INDIA

Bangalore - Karnataka
Teléfono: +91 80 41282007
info-in@weg.net

Hosur - Tamil Nadu
Teléfono: +91 4344 301577
info-in@weg.net

ITALIA

Cinisello Balsamo - Milano
Teléfono: +39 2 61293535
info-it@weg.net

JAPON

Yokohama - Kanagawa
Teléfono: +81 45 5503030
info-jp@weg.net

MALASIA

Shah Alam - Selangor
Teléfono: +60 3 78591626
info@wattdrive.com.my

MEXICO

Huehuetoca - Mexico
Teléfono: +52 55 53214275
info-mx@weg.net

Tizayuca - Hidalgo
Teléfono: +52 77 97963790

PAISES BAJOS

Oldenzaal - Overijssel
Teléfono: +31 541 571080
info-nl@weg.net

PERU

La Victoria - Lima
Teléfono: +51 1 2097600
info-pe@weg.net

PORTUGAL

Maia - Porto
Teléfono: +351 22 9477700
info-pt@weg.net

RUSIA y CEI

Saint Petersburg
Teléfono: +7 812 363 2172
sales-wes@weg.net

SINGAPOR

Singapor
Teléfono: +65 68589081
info-sg@weg.net

Singapor
Teléfono: +65 68622220
watteuro@watteuro.com.sg

SUDAFRICA

Johannesburg
Teléfono: +27 11 7236000
info@zest.co.za

SUECIA

Mölnlycke - Suecia
Teléfono: +46 31 888000
info-se@weg.net

REINO UNIDO

Redditch - Worcestershire
Teléfono: +44 1527 513800
info-uk@weg.net

VENEZUELA

Valencia - Carabobo
Teléfono: +58 241 8210582
info-ve@weg.net

Para los países donde no hay una operación WEG, encuentre el distribuidor local en www.weg.net.



Grupo WEG - Unidad Automatización
Jaraguá do Sul - SC - Brasil
Teléfono: +55 (47) 3276-4000
automacao@weg.net
www.weg.net

